



FOCUS PROFILE



User Manual

©2022 ADJ Products, LLC all rights reserved. Information, specifications, diagrams, images, and instructions herein are subject to change without notice. ADJ Products, LLC logo and identifying product names and numbers herein are trademarks of ADJ Products, LLC. Copyright protection claimed includes all forms and matters of copyrightable materials and information now allowed by statutory or judicial law or hereinafter granted. Product names used in this document may be trademarks or registered trademarks of their respective companies and are hereby acknowledged. All non-ADJ Products, LLC brands and product names are trademarks or registered trademarks of their respective companies.

ADJ Products, LLC and all affiliated companies hereby disclaim any and all liabilities for property, equipment, building, and electrical damages, injuries to any persons, and direct or indirect economic loss associated with the use or reliance of any information contained within this document, and/or as a result of the improper, unsafe, insufficient and negligent assembly, installation, rigging, and operation of this product.



DOCUMENT VERSION

Due to additional product features and/or enhancements, an updated version of this document may be available online.

Please check www.adj.com for the latest revision/update of this manual before beginning installation and/or programming.

Date	Document Version	Software Version	DMX Channels	Notes
01/03/2022	1.0	1.2.4	36 / 40 / 51 channels	Initial Release
02/08/2022	1.1	N/C	No Change	Updated Gobos, DMX Traits
03/21/2022	1.2	N/C	No Change	Updated Gobos to add dimensions
04/14/2022	1.3	N/C	No Change	Updated System Menu, Specifications
05/16/2022	1.4	N/C	No Change	Updated Dimensional Drawings and Specifications

Europe Energy Saving Notice

Energy Saving Matters (EuP 2009/125/EC)

Saving electric energy is a key to help protecting the environment. Please turn off all electrical products when they are not in use. To avoid power consumption in idle mode, disconnect all electrical equipment from power when not in use. Thank you!

TABLE OF CONTENTS

General Information	4
Key Features Warranty Returns	5
Limited Warranty (USA Only)	6
Safety Guidelines	7
Overview	8
DMX Set Up	9
Installation	11
Accessory Installation	15
Remote Device Management (RDM)	18
Gobo Replacement	19
Control Panel	24
System Menu	25
DMX Addressing	30
DMX Traits	31
White Color Temperature Presets	42
Color Wheel	43
Gobos	44
Dimmer Modes and Curves	45
Frame Macros Table	46
Cleaning and Maintenance	47
Fuse Replacement Software Updates	48
Dimensional Drawings	49
Specifications	50
Error Codes	51

GENERAL INFORMATION

Introduction: Congratulations on your purchase of the ADJ Focus Profile! This device is a 400W, CMY (Cyan, Magenta, Yellow), LED moving head spot, and has been designed to perform reliably for years when the guidelines in this booklet are followed. Please read and understand the instructions in this manual carefully and thoroughly before attempting to operate this device. These instructions contain important information regarding safety during use and maintenance.

Please keep this manual with the device for future reference.

Customer Support: Contact ADJ Service for any product related service and support needs. Also visit forums.adj.com with questions, comments or suggestions.

Parts: To purchase parts online visit:

<http://parts.adj.com> (US)

<http://www.adjparts.eu> (EU)

ADJ SERVICE USA - Monday - Friday 8:00am to 4:30pm PST

Voice: 800-322-6337 | Fax: 323-582-2941 | support@adj.com

ADJ SERVICE EUROPE - Monday - Friday 08:30 to 17:00 CET

Voice: +31 45 546 85 60 | Fax: +31 45 546 85 96 | support@adj.eu

ADJ PRODUCTS LLC USA

6122 S. Eastern Ave. Los Angeles, CA. 90040

323-582-2650 | Fax 323-532-2941 | www.adj.com | info@adj.com

ADJ SUPPLY Europe B.V

Junostraat 2 6468 EW Kerkrade, The Netherlands

+31 (0)45 546 85 00 | Fax +31 45 546 85 99

www.adj.eu | info@adj.eu

ADJ PRODUCTS GROUP Mexico

AV Santa Ana 30 Parque Industrial Lerma, Lerma, Mexico 52000

+52 (728) 282-7070

WARNING! To prevent or reduce the risk of electrical shock or fire, do not expose this unit to rain or moisture.

CAUTION! There are no user serviceable parts inside this unit. Do not attempt any repairs yourself, as doing so will void your manufacturer's warranty. In the unlikely event your unit may require service, please contact ADJ Products, LLC.

Do not discard the shipping carton in the trash. Please recycle when ever possible.

KEY FEATURES

- 400W LED engine
- 20,000 total lumens (fully zoomed out)
- 7 to 45 degree zoom range
- 6,700K color temperature
- >70 CRI
- 4 rotating framing shutter blades
- Full CMY color mixing
- 0-100% variable CTO

INCLUDED ITEMS:

- Twist-lock power cable (x1)
- Omega brackets (x2)
- Heavy Frost Lens (x1)

WARRANTY RETURNS

All returned service items, whether under warranty or not, must be freight pre-paid and accompanied by a return authorization (R.A.) number. The R.A. number must be clearly written on the outside of the return package. A brief description of the problem as well as the R.A. number must also be written down on a piece of paper included in the shipping carton. If the unit is under warranty, you must provide a copy of your proof of purchase invoice. You may obtain an R.A. number by contacting our customer support team. All packages returned to the service department not displaying an R.A. number on the outside of the package will be returned to the shipper.

LIMITED WARRANTY (USA ONLY)

- A. ADJ Products, LLC hereby warrants, to the original purchaser, ADJ Products, LLC products to be free of manufacturing defects in material and workmanship for a prescribed period from the date of purchase (see specific warranty period on reverse). This warranty shall be valid only if the product is purchased within the United States of America, including possessions and territories. It is the owner's responsibility to establish the date and place of purchase by acceptable evidence, at the time service is sought.
- B. For warranty service, you must obtain a Return Authorization number (RA#) before sending the product back—please contact ADJ Products, LLC Service Department at 800-322-6337. Send the product only to the ADJ Products, LLC factory. All shipping charges must be prepaid. If the requested repairs or service (including parts replacement) are within the terms of this warranty, ADJ Products, LLC will pay return shipping charges only to a designated point within the United States. If the entire instrument is sent, it must be shipped in its original package and packaging material. No accessories should be shipped with the product. If any accessories are shipped with the product, ADJ Products, LLC shall incur no liability whatsoever for loss of or damage to any such accessories, nor for the safe return thereof.
- C. This warranty is void if the product serial number and/or labels are altered or removed; if the product is modified in any manner which ADJ Products, LLC concludes, after inspection, affects the reliability of the product; if the product has been repaired or serviced by anyone other than the ADJ Products, LLC factory unless prior written authorization was issued to purchaser by ADJ Products, LLC; if the product is damaged because it was not properly maintained as set forth in the product instructions, guidelines and/or user manual.
- D. This is not a service contract, and this warranty does not include maintenance, cleaning, or periodic checkup. During the period specified above, ADJ Products, LLC will replace defective parts at its expense with new or refurbished parts, and will absorb all expenses for warranty service and repair labor by reason of defects in material or workmanship. The sole responsibility of ADJ Products, LLC under this warranty shall be limited to the repair of the product, or replacement thereof, including parts, at the sole discretion of ADJ Products, LLC. All products covered by this warranty were manufactured after August 15, 2012, and bear identifying marks to that effect.
- E. ADJ Products, LLC reserves the right to make changes in design and/or improvements upon its products without any obligation to include these changes in any products theretofore manufactured.
- F. No warranty, whether expressed or implied, is given or made with respect to any accessory supplied with products described above. Except to the extent prohibited by applicable law, all implied warranties made by ADJ Products, LLC in connection with this product, including warranties of merchantability or fitness, are limited in duration to the warranty period set forth above. And all warranties, whether expressed or implied, including warranties of merchantability or fitness, are limited in duration to the warranty period set forth above. The consumer's and/or dealer's sole remedy shall be such repair or replacement as is expressly provided above; and under no circumstances shall ADJ Product, LLC be liable for any loss and/or damage, direct and/or consequential arising out of the use of, and/or inability to use this product.
- G. This warranty is the only written warranty applicable to ADJ Products, LLC products, and supersedes all prior warranties and written descriptions of warranty terms and conditions heretofore published.

MANUFACTURER'S LIMITED WARRANTY PERIODS:

- Non-LED Lighting Products = 1-Year (365 Days) (Including Special Effect Lighting, Intelligent Lighting, UV lighting, Strobes, Fog Machines, Bubble Machines, Mirror Balls, Par Cans, Trussing, Lighting Stands, Power/Data Distribution, etc. excluding LED and lamps)
- Laser Products = 1-Year (365 Days) (excluding laser diodes which have a 6-Month Limited Warranty)
- LED Products = 2-Year (730 Days) (excluding batteries which have a 180 Day Limited Warranty)
- NOTE: 2-Year (730 Days) Limited Warranty ONLY applies to product purchased within the United States. StarTec Series = 1-Year (365 Days) (excluding batteries which have a 180 Day Limited Warranty)
- ADJ DMX Controllers = 2 Year (730 Days)
- American Audio Products = 1 Year (365 Days)

SAFETY GUIDELINES

For Your Own Personal Safety, Please Read and Understand This Manual Completely Before You Attempt To Install Or Operate This Unit!

- Be sure to save the packing carton in the unlikely event the device may have to be returned for service.
- Do not spill water or other liquids into or on to the device.
- Be sure that the local power outlet matches the required voltage for the device.
- Do not open up the device for any reason. There are no user serviceable parts inside.
- Disconnect the device's main power when left unused for long periods of time.
- Never connect this device to a dimmer pack.
- Do not attempt to operate this device if it has been damaged in any way.
- Never operate this device with the cover removed.
- To reduce the risk of electrical shock or fire, do not expose this device to rain or moisture.
- Do not attempt to operate this device if the power cord has been frayed or broken.
- Do not attempt to remove or break off the ground prong from the electrical cord. This prong is used to reduce the risk of electrical shock and fire in case of an internal short.
- Disconnect from main power before making any type of connection.
- Never block the ventilation holes. Always be sure to mount this device in an area that will allow proper ventilation. Allow about 6" (15cm) between this device and a wall.
- This unit is intended for indoor use only. Use of this product outdoors voids all warranties.
- Always mount this unit in a safe and stable matter.
- Please route your power cord out of the way of foot traffic. Power cords should be routed so they are not likely to be walked on, or pinched by items placed upon or against them.

Maximum ambient operating temperature for this fixture is 113 degrees F (45 degrees C). Do not operate this device when ambient temperature exceeds this value!

Keep flammable materials away from this fixture!

FIXTURE IS DESIGNED FOR INDOOR USE ONLY! DO NOT EXPOSE TO RAIN OR MOISTURE!

The device should be serviced by qualified service personnel when:

- A. The power-supply cord or the plug has been damaged.
- B. Objects have fallen on, or liquid has been spilled into, the device.
- C. The device has been exposed to rain or water.
- D. The appliance does not appear to operate normally or exhibits a marked change in performance.

OVERVIEW

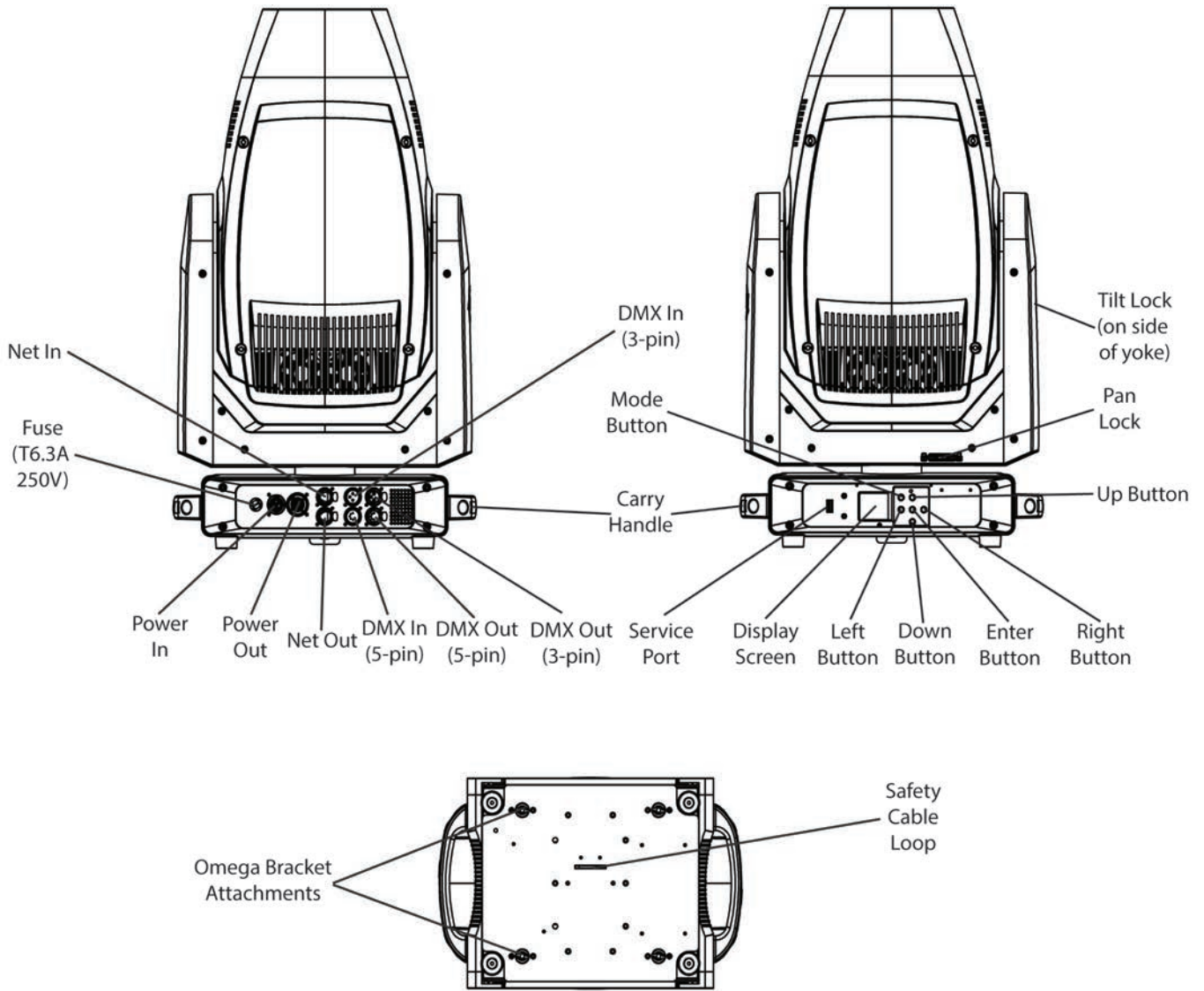

DMX SET UP

DMX-512: DMX is short for Digital Multiplex. This is a universal protocol used as a form of communication between intelligent fixtures and controllers. A DMX controller sends DMX data instructions from the controller to the fixture. DMX data is sent as serial data that travels from fixture to fixture via the DATA “IN” and DATA “OUT” XLR terminals located on all DMX fixtures (most controllers only have a DATA “OUT” terminal).

DMX Linking: DMX is a language allowing all makes and models of different manufacturers to be linked together and operate from a single controller, as long as all fixtures and the controller are DMX compliant. To ensure proper DMX data transmission, try to use the shortest cable path possible when linking several DMX fixtures. The order in which fixtures are connected in a DMX line does not influence the DMX addressing. For example, a fixture assigned a DMX address of 1 may be placed anywhere in a DMX line: at the beginning, at the end, or anywhere in the middle. When a fixture is assigned a DMX address of 1, the DMX controller knows to send DATA assigned to address 1 to that unit, no matter where it is located in the DMX chain.

Data Cable (DMX Cable) Requirements (For DMX Operation): The Focus Profile can be controlled via DMX-512 protocol. The DMX address is set on the front panel of the fixture. Your unit and your DMX controller require a standard 3-pin XLR connector for data input and data output. We recommend Accu-Cable DMX cables. If you are making your own cables, be sure to use standard 110-120 Ohm shielded cable (This cable may be purchased at almost all pro lighting stores). Your cables should be made with a male XLR connector at one end and a female XLR connector on the other. Also remember that DMX cable must be daisy chained and cannot be split.

Notice: Be sure to follow figures 1 and 2 when making your own cables. Do not use the ground lug on the XLR connector. Do not connect the cable’s shield conductor to the ground lug or allow the shield conductor to come in contact with the XLR’s outer casing. Grounding the shield could cause a short circuit and may result in erratic behavior.



Figure 1

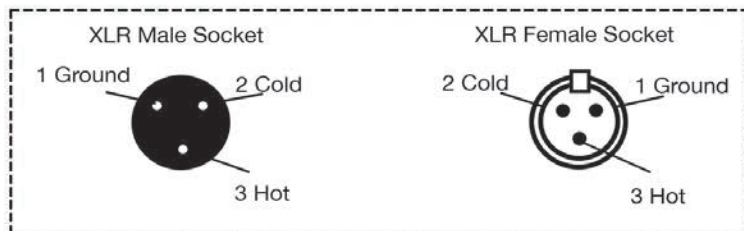
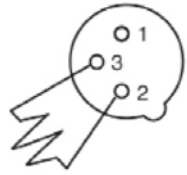

Figure 2

XLR Pin Configuration
Pin 1 = Ground
Pin 2 = Data Compliment (negative)
Pin 3 = Data True (positive)

DMX SET UP

Special Note: Line Termination. When longer runs of cable are used, you may need to use a terminator on the last unit to avoid erratic behavior. A terminator is a 110-120 ohm 1/4 watt resistor which is connected between pins 2 and 3 of a male XLR connector (DATA + and DATA -). This unit is inserted in the female XLR connector of the last unit in your daisy chain to terminate the line. Using a cable terminator (ADJ part number **Z-DMX/T**) will decrease the possibilities of erratic behavior.



Termination reduces signal errors and avoids signal transmission problems and interference. It is always advisable to connect a DMX terminal, (Resistance 120 Ohm 1/4 W) between PIN 2 (DMX-) and PIN 3 (DMX +) of the last fixture.

5-Pin XLR DMX Connectors. Some manufacturers use 5-pin DMX-512 data cables for DATA transmission in place of 3-pin. 5-pin DMX fixtures may be implemented in a 3-pin DMX line. When inserting standard 5-pin data cables into a 3-pin line, a cable adaptor must be used. These adaptors are readily available at most electronics stores. The chart below details a proper cable conversion.

3-Pin XLR to 5-Pin XLR Conversion		
Conductor	3-Pin XLR Female (Out)	5-Pin XLR Male (In)
Ground/Shield	Pin 1	Pin 1
Data Compliment (- signal)	Pin 2	Pin 2
Data True (+ signal)	Pin 3	Pin 3
Not Used		Do Not Use
Not Used		Do Not Use

INSTALLATION

IP RATING

This device is **IP20** rated. It is protected against intrusion of solids larger than 12.5mm in size, or approximately the size of an adult finger. **The device is NOT protected against liquid intrusion of any kind.**

FLAMMABLE MATERIAL WARNING!

Keep device a minimum of 5.0 feet (1.5m) away from flammable material and/or pyrotechnics.

ELECTRICAL CONNECTIONS

A qualified electrician should be used for all electrical connections and/or installations.

MULTI-DEVICE DAISY CHAINING

- When connected to 240V power, up to 2 devices may be daisy chained together.
- **When connected to 110V power, daisy chaining is NOT permitted. In this situation, only operate the fixture as a single standalone device!**

DO NOT INSTALL THE DEVICE IF YOU ARE NOT QUALIFIED TO DO SO!

The unit **MUST** be installed following all local, national, and country commercial electrical and construction codes and regulations.

Before installing or mounting any device, a professional equipment installer **MUST** be consulted to determine whether the mounting structure or surface is properly certified to safely support the combined weight of the fixture, clamps, cables, and accessories.

Overhead fixture installations must always be secured with a secondary safety attachment, such as an appropriately rated safety cable that meets all local, national, and country codes and regulations.

Maximum ambient operating temperature is **113°F (45°C)**. Do not operate this device when ambient temperature exceeds this value.

This fixture should be installed in areas outside walking paths, seating areas, and areas where unauthorized personnel might be able to reach the device by hand.

NEVER stand directly below the fixture when rigging, removing, or servicing.

Allow approximately 15 minutes for the fixture to cool down before servicing.

INSTALLATION

POTENTIAL INTERNAL FIXTURE DAMAGE FROM EXTERNAL SOURCES OF LIGHT BEAMS

External sources of light beams from direct sunlight, lighting moving head fixtures, and lasers which are focused directly towards the exterior housing and/or penetrate the front lens opening of ADJ lighting fixtures can cause severe internal damage including burning of optics, dichroic color filters, glass and metal gobos, prisms, animation wheels, frost filters, irises, shutters, motors, belts, wiring, discharge lamps, and LEDs.

This issue is not unique to ADJ lighting fixtures; it is a common issue with lighting fixtures from all manufacturers. Although there is no true way to fully prevent this issue from happening, the guidelines below can reduce the risk of any potential damage if followed. Contact ADJ Service for more details.

DO NOT EXPOSE THE FIXTURE AND/OR FRONT LENS OPENING TO LIGHT BEAMS FROM DIRECT SUNLIGHT, OTHER LIGHTING MOVING HEAD FIXTURES, AND LASERS DURING UNPACKING, INSTALLATION, USE, AND EXTENDED IDLE TIMES OUTDOORS.
DO NOT FOCUS A LIGHT BEAM FROM ONE LIGHTING FIXTURE DIRECTLY TOWARDS ANOTHER.

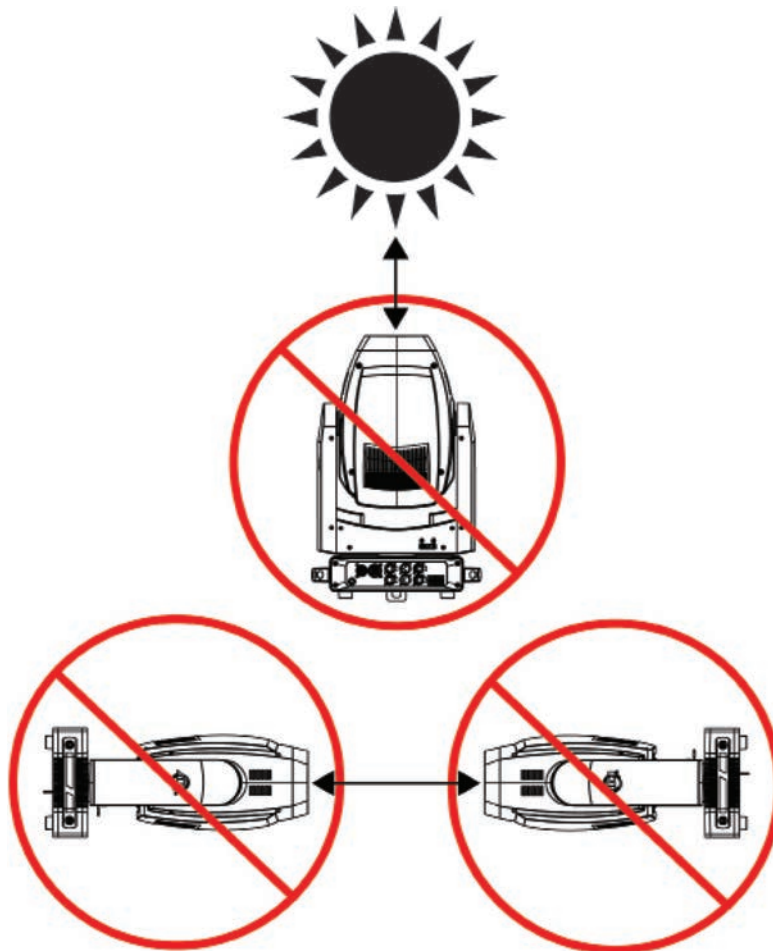

INSTALLATION

CLAMP INSTALLATION

This fixture features multiple mounting clamp attachment points, as well as a safety cable attachment point, located on the bottom face of the fixture (see the illustration below). When mounting the fixture to a truss or any other suspended or overhead installation, be sure to secure appropriately rated clamps (not included) to the clamp attachment points and attach a separate **SAFETY CABLE** of the appropriate safety rating to the safety cable rigging point.

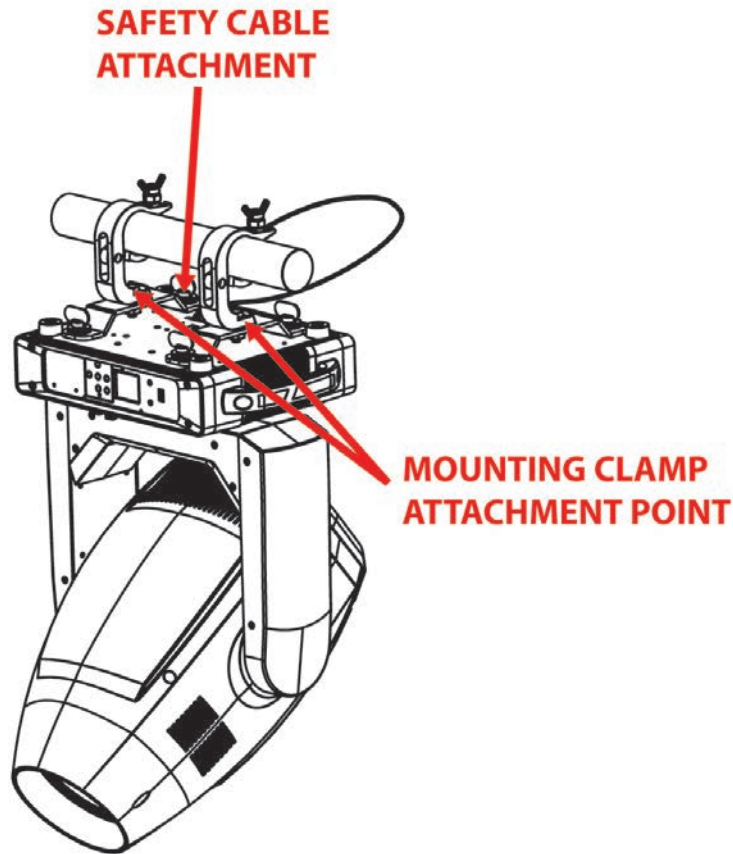

SAFETY CABLE

ALWAYS ATTACH A SAFETY CABLE WHENEVER INSTALLING THIS FIXTURE IN A SUSPENDED ENVIRONMENT TO ENSURE THAT THE FIXTURE WILL NOT FALL IF THE CLAMP FAILS.

RIGGING

Overhead rigging requires extensive experience, including but not limited to: calculating working load limits, understanding the installation material being used, and periodic safety inspection of all installation material and the fixture itself. If you lack these qualifications, do not attempt to perform the installation yourself. Improper installation can result in bodily injury.

INSTALLATION

NOTICE: The max suitable environmental temperature for this lighting fixture is **45° C**. Do not place this lighting fixture in an environment where the temperatures exceed this rating. This will allow the fixture to run at its best and help prolong the fixture life.

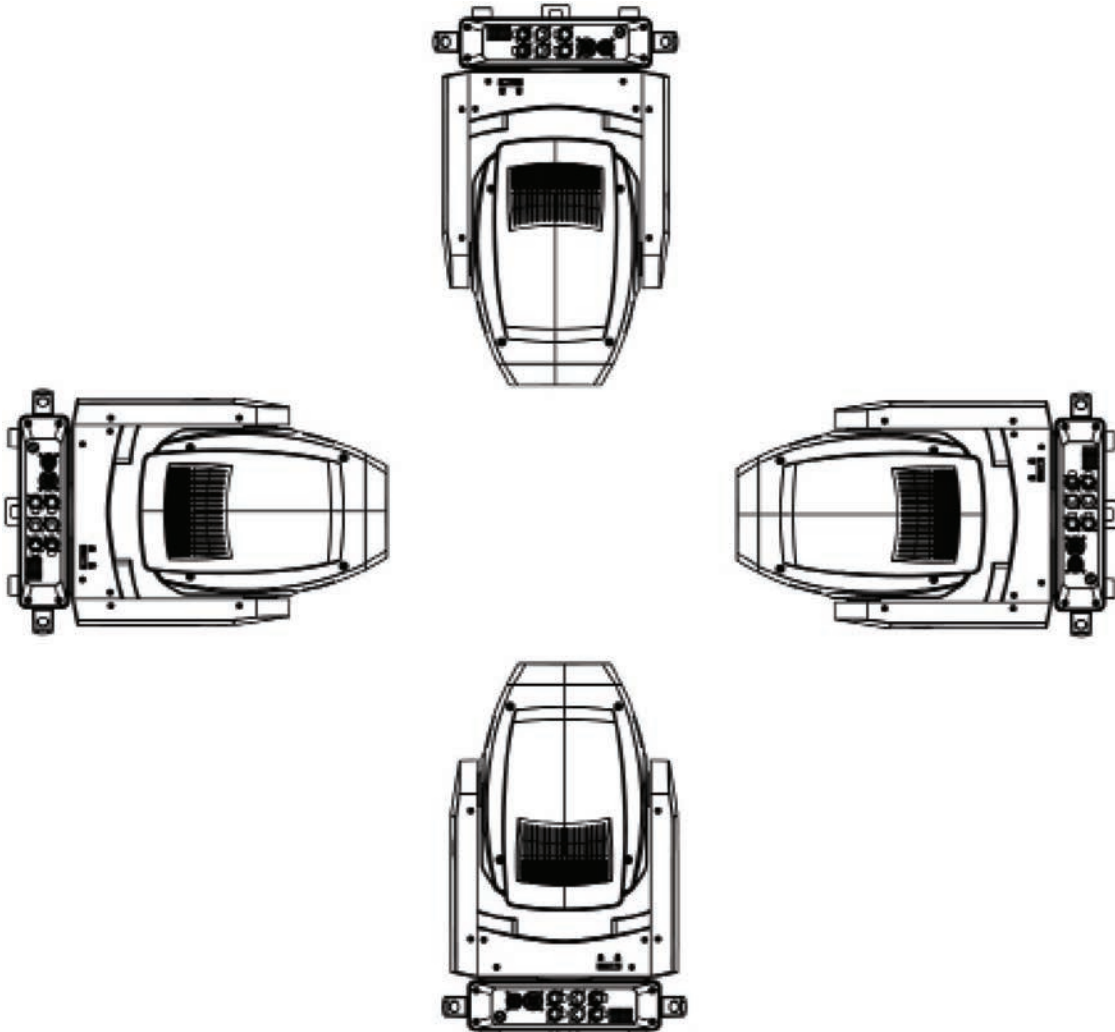

The Focus Profile is fully operational in three different mounting positions: hanging upside-down from a ceiling or trussing, sideways on trussing, or set on a flat level surface. Be sure this fixture is kept at least 12m (40ft) away from any flammable materials (decoration etc.). Always use and install a safety cable (not included) as a safety measure to prevent accidental damage and/or injury in the event the clamp fails. Never use the carrying handles for secondary attachment.

ACCESSORY INSTALLATION

FROST FILTER

1. Orient the head vertically, and engage the unit's pan and tilt locks. Locate and loosen the four twist-lock fasteners on each side of the head casing, as illustrated below. Remove the safety clip at the bottom of each side of the head casing, and remove both halves of the head casing.



2. Locate the frost filter inside the head. It should be located on the sliding module closest to the external lens at the top of the head (below left). Within this module, the frost filter is a circular filter mounted on an arm attached to an elevated motor (below right).

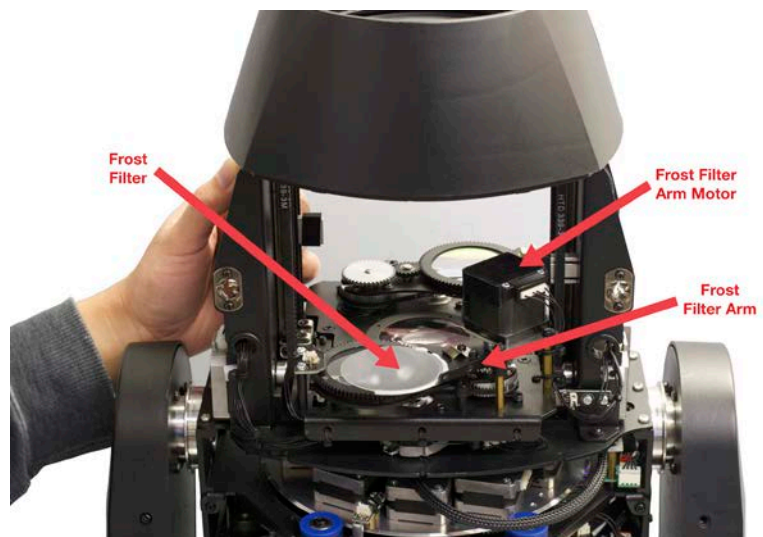
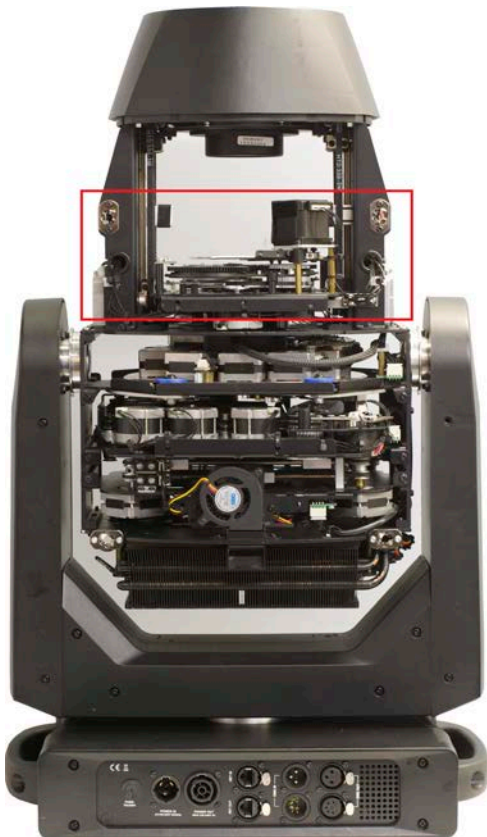

ACCESSORY INSTALLATION

FROST FILTER

3. Gently pull the frost filter arm back towards the large lens in the center of the sliding module. This will expose two small screws on the arm. Remove these screws, being careful not to drop them. Please note that the arm is spring-loaded and needs to be held in place while removing the screws. The frost filter can now be removed.

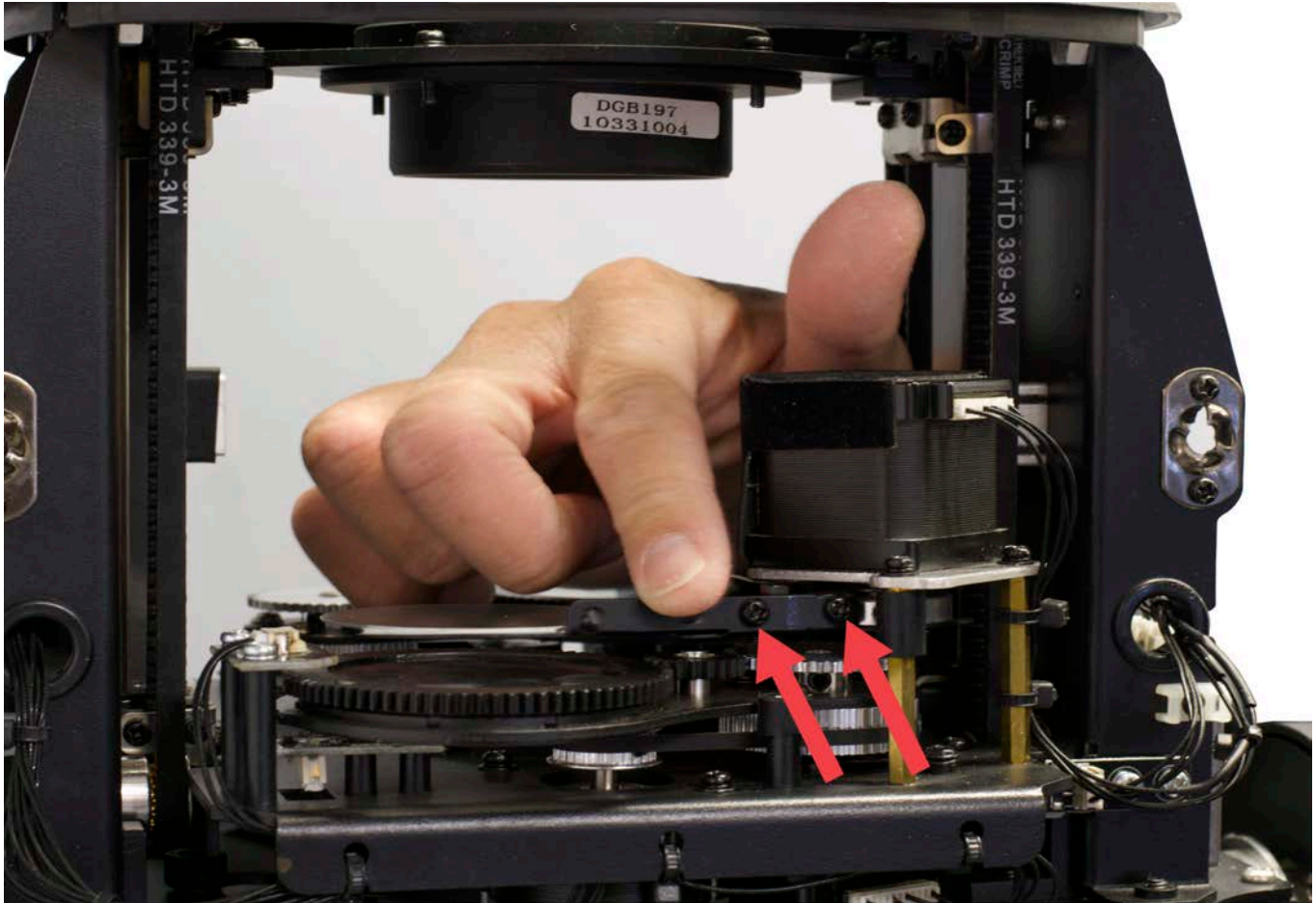

ACCESSORY INSTALLATION

FROST FILTER

- Slide the new frost filter holder in place on the arm, making sure that the edge of the frost filter holder slips into place beneath the small silver clip on the motorized arm (see below). Secure the new frost filter holder by re-inserting and tightening the two small screws on the edge of the motorized arm.

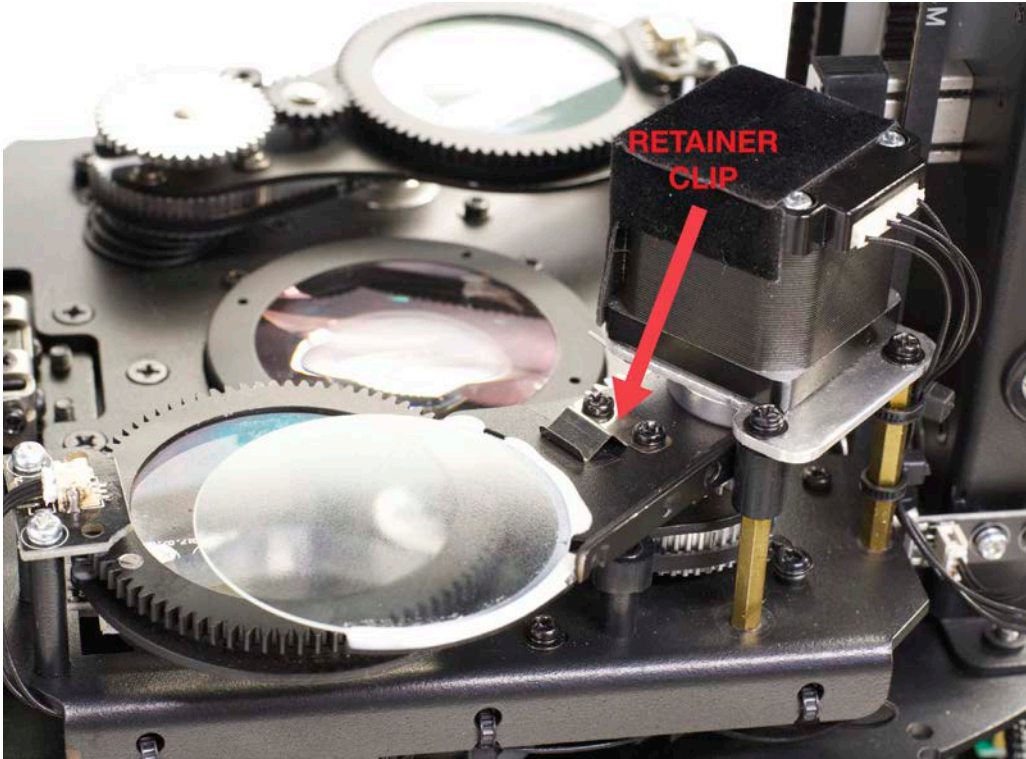

- Re-install both sides of the head casing by re-securing the clips at the bottom, then tightening the four twist-lock fasteners on each side. The installation is now complete.

REMOTE DEVICE MANAGEMENT (RDM)

NOTE: In order for RDM to work properly, RDM enabled equipment must be used throughout the entire system, including DMX data splitters and wireless systems.

Remote Device Management (RDM) is a protocol that sits on top of the DMX512 data standard for lighting, and allows the DMX systems of the fixtures to be modified and monitored remotely. This protocol is ideal for instances in which a unit is installed in a location that is not easily accessible.

With RDM, the DMX512 system becomes bi-directional, allowing a compatible RDM enabled controller to send out a signal to devices on the wire, as well as allowing the fixture to respond (known as a GET command). The controller can then use its SET command to modify settings that would typically have to be changed or viewed directly via the unit's display screen, including the DMX Address, DMX Channel Mode, and Temperature Sensors.

Please be aware that **not all RDM devices support all RDM features**, and therefore it is important to check beforehand to ensure that the equipment that you are considering includes all of the features that you require.

The following parameters are accessible in RDM on this device:

SENSOR DEFINITION	LAMP HOURS
SENSOR VALUE	LAMP STATE
DEVICE MODEL DESCRIPTION	PAN INVERT
MANUFACTURER LABEL	TILT INVERT
DEVICE LABEL	DISPLAY INVERT
DMX PERSONALITY	REALTIME CLOCK
DMX PERSONALITY DESCRIPTION	BOOT SOFTWARE VERSION LABEL
DEVICE HOURS	BOOT SOFTWARE VERSION ID
COMMS STATUS	PRODUCT DETAIL ID LIST
STATUS ID DESCRIPTION	STATUS MESSAGES
CLEAR STATUS ID	

GOBO REPLACEMENT

1. Engage both the pan and tilt locks. Use a screwdriver to loosen the 4 fasteners that secure the cover (left), then unclip the security cable (right) and remove the cover. Repeat this process for both halves of the cover.

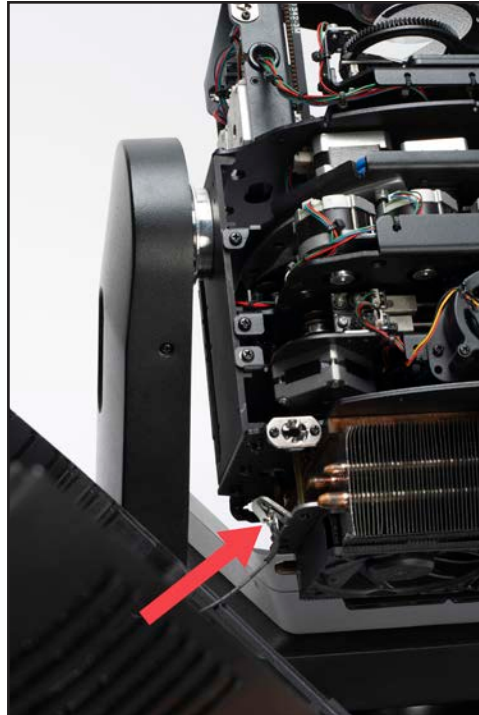

2. Position the head so that the side with the small fan (located near the bottom of the head) is facing towards you. Locate the gobo wheel module, which prominently features a row of 3 stepper motors. From there, find and disconnect the electrical connector on the right-hand side of the module, near the effect wheel.

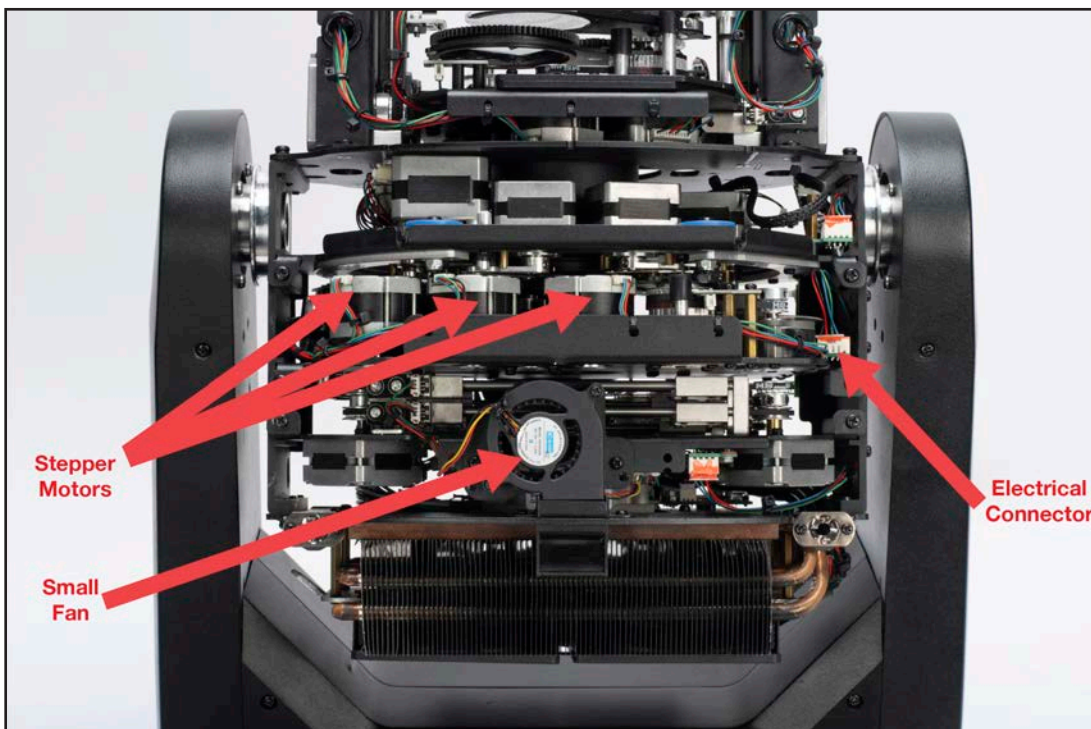

GOBO REPLACEMENT

3. Locate the two screws that hold the gobo wheel module in place. The first screw is located below and left of the stepper motors, and the second is located below and right of the electrical connector that was disconnected in Step 2.

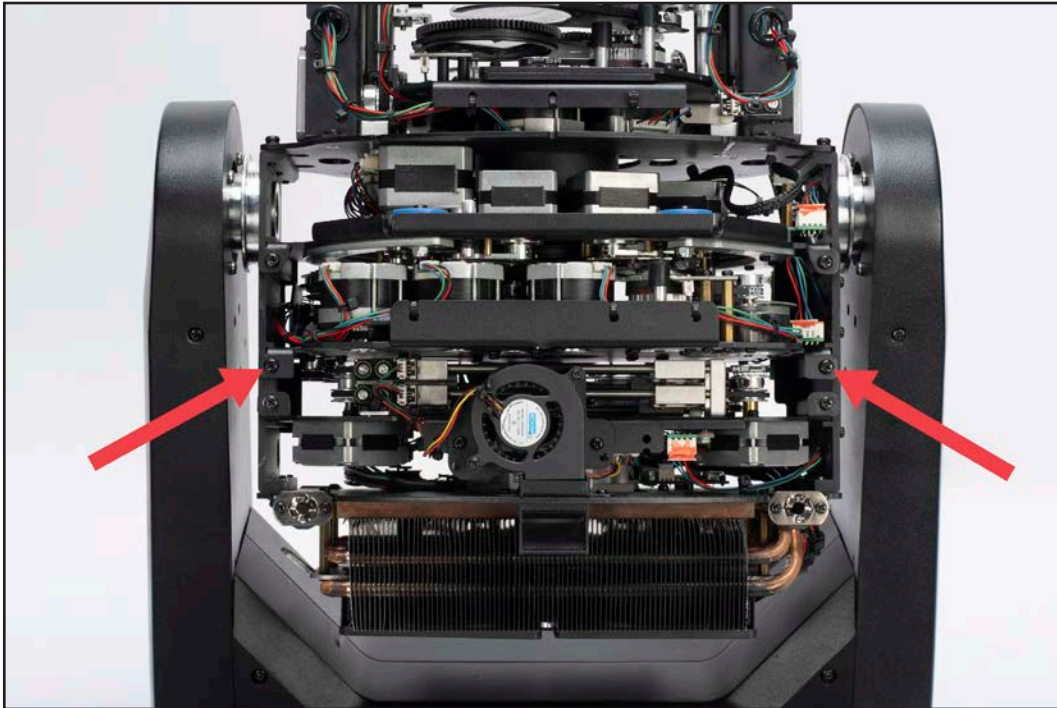

4. Remove the gobo wheel module from the head. Locate the open area between the left-most stepper motor and the gobo wheel. This is the location that will be used to remove the desired gobo. Please beware of damaging the sensor beneath the gobo wheel at this location.

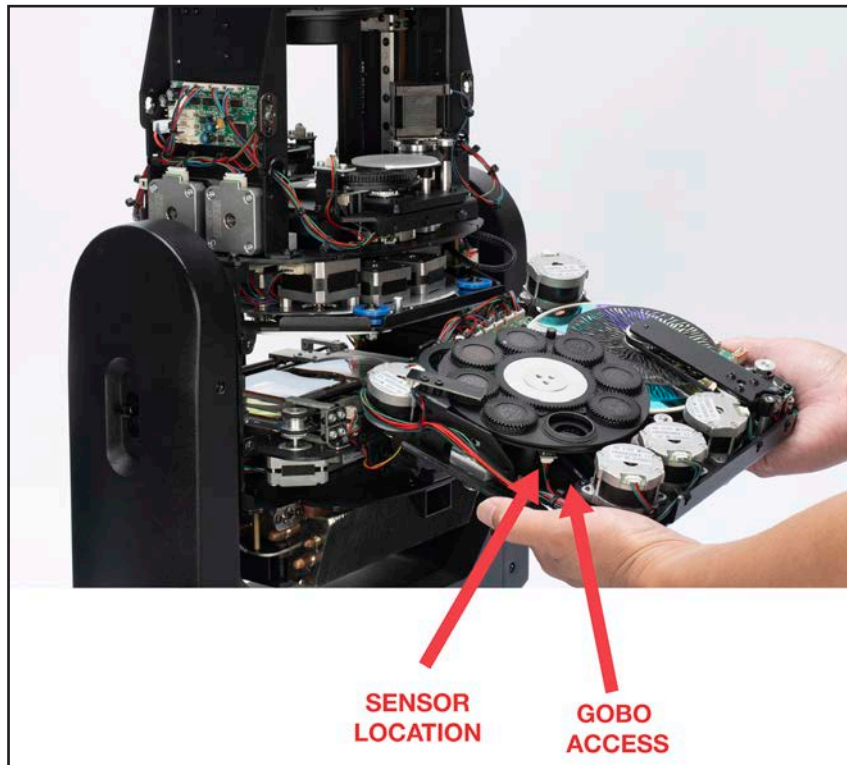

GOBO REPLACEMENT

5. Rotate the replaceable gobo wheel (top wheel) so that the gobo you wish to replace is positioned near the open area just behind the left-most stepper motor. Then rotate the non-replaceable gobo wheel (bottom wheel) so that the open slot is aligned with the gobo you wish to replace. The top image shows the 2 gobo wheels out of alignment; the bottom image shows the 2 wheels aligned as desired.

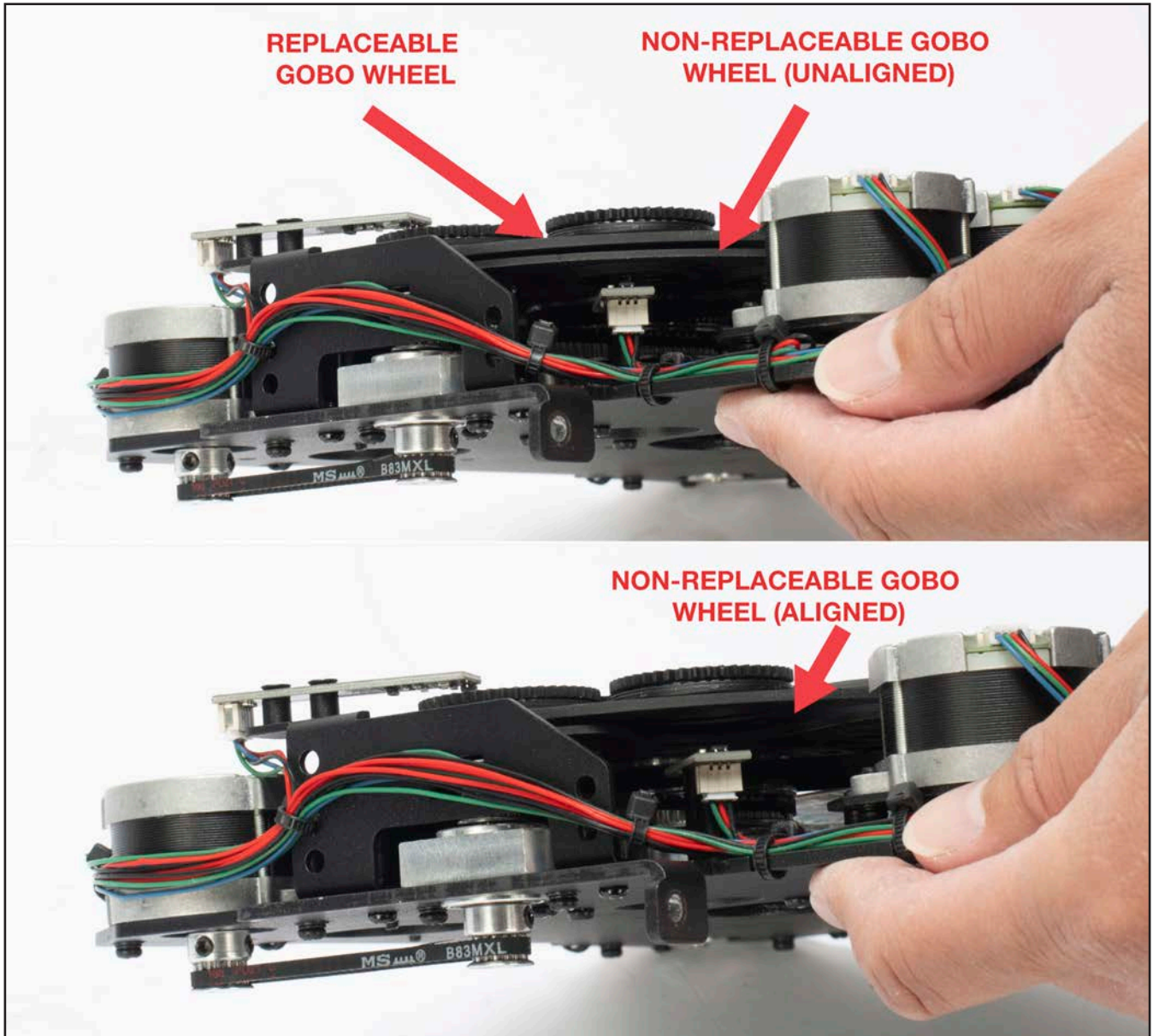

GOBO REPLACEMENT

6. Firmly grasp the holder of the gobo you wish you replace by the toothed gear portion. Lift the gobo upward, gently pushing from below with a finger if necessary (left), then pull the holder outward (right) to remove from the gobo wheel.

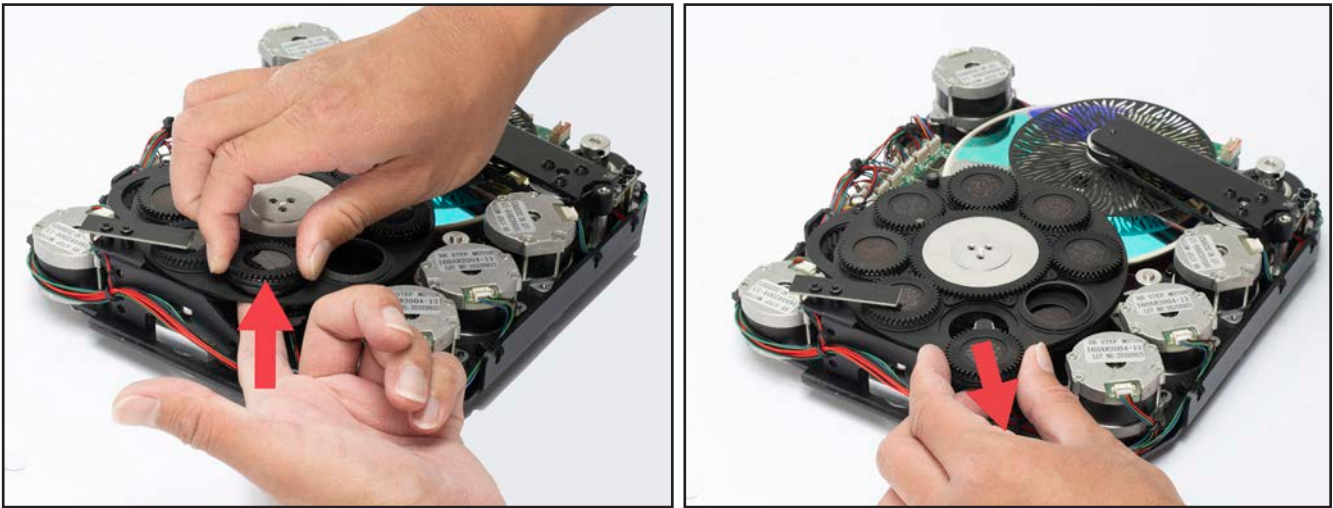

7. Turn the holder over so that the gear side is facing downwards. Carefully use a pick to catch the spring tab and release the retainer spring (left). **Be careful to avoid scratching the gobo.** Remove the retainer spring, then remove the gobo (right).



GOBO REPLACEMENT

- Place the new gobo in the gobo holder, and re-install the retainer spring.
- Manually rotate the silver central gear of the gobo wheel so that the positioning mark is aligned with the slot where you will be installing the new gobo.

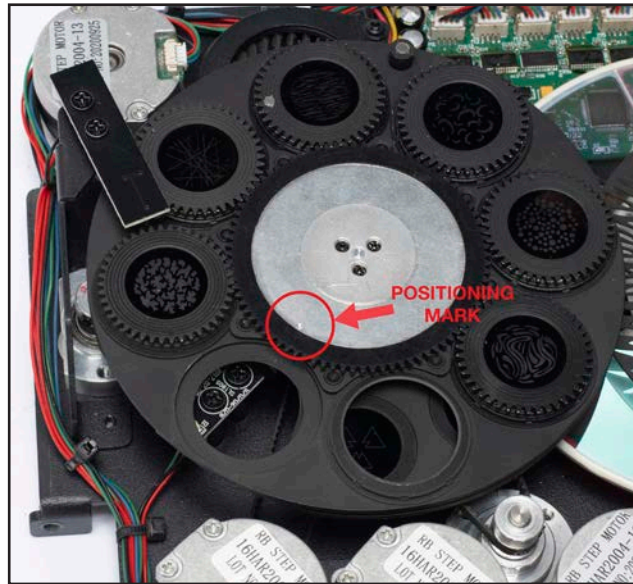

- Turn the gobo holder back over so that the gear side is facing upwards. Position the mark on the gobo holder so that it aligns with the mark on the gobo wheel, then slide the prong on the gobo holder into the slot on the gobo wheel until it clicks into place.

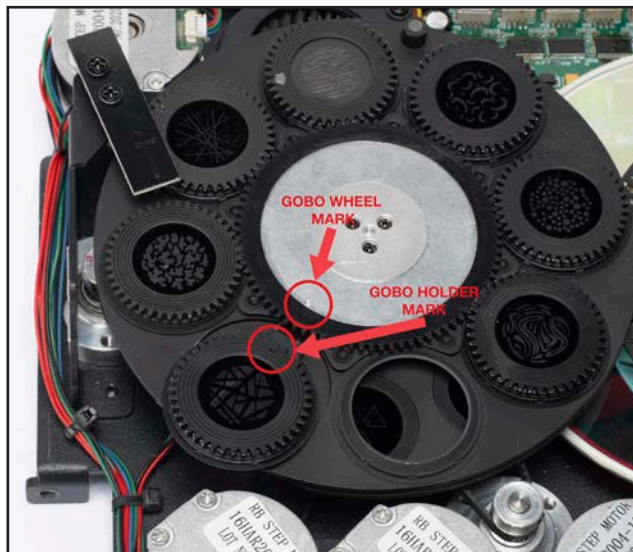

- Re-assemble the moving head by reversing steps 1-4.

CONTROL PANEL

This fixture includes an easy to navigate control panel display, from which all necessary settings and adjustments can be made. During normal operation, pressing the **MODE** button once will access the fixture's main menu. Once in the main menu, the **UP** and **DOWN** buttons can be used to navigate through the different functions. Press the **ENTER** button to select the option displayed on the screen, and use the **LEFT** and **RIGHT** buttons to adjust the settings for the selected option. Press the **ENTER** button once more to confirm the setting. Press the **MODE** button at any time to return to the main menu without making any adjustments.

The fixture also includes an internal battery that allows users to operate the screen and control panel even when the fixture is not plugged in. To access the system menu when the fixture is running on internal battery power, press and hold the **MODE** button to illuminate the display screen until the DMX address is displayed, then navigate to the desired system menu.

Please note that the battery is only capable of powering the screen and control panel, and that the fixture is NOT capable of illuminating while on battery power.

The screen display can be quickly inverted without navigating through the system menu. To do so, simply press the **RIGHT** button once to invert the display, and press the **RIGHT** button again to undo the display inversion.

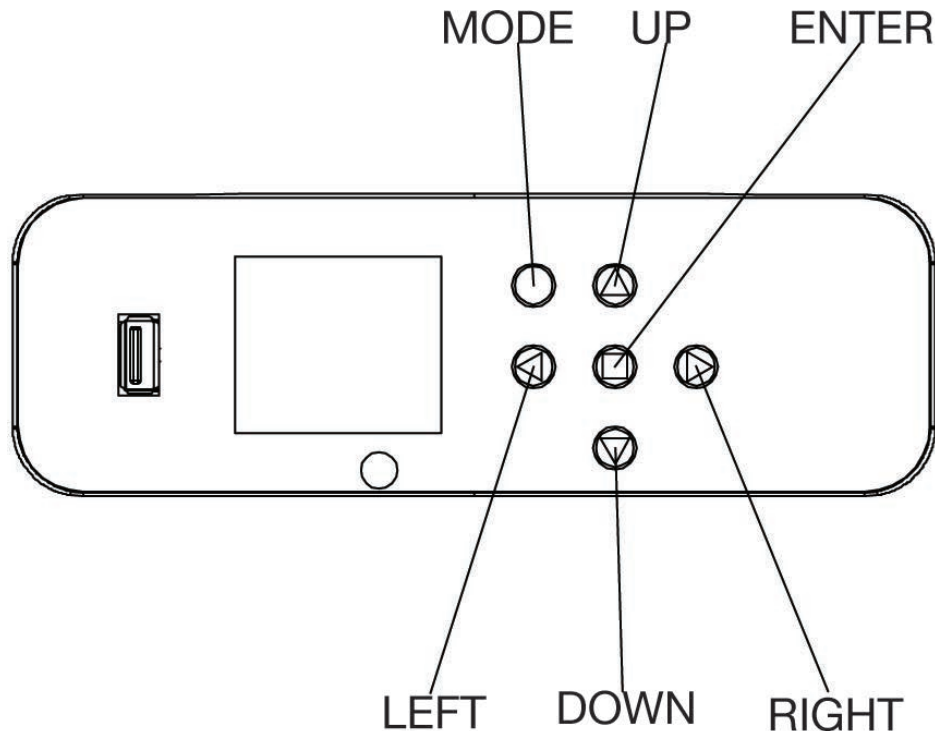

SYSTEM MENU

DMX SETTINGS	Set Address	A001~AXXX			
	DMX Channel Mode	Standard 40			
		Basic 36			
		Extended 51			
	No DMX Status	Hold Last			
		Blackout			
Manual					
PERSONALITY	Status Settings	Primary	On / Off		
		Secondary	On / Off		
		Pan Degree	630 / 540		
		Pan Invert	On / Off		
		Tilt Invert	On / Off		
		P./T. Feedback	On / Off		
		P.T. Speed	Speed1 / Speed2		
		Hibernation	Off, 01M~99M Default = 15M		
	Fixture ID	Service PIN	Password = 050		
		Universe	000 - 255		
		UnitIPAddr	xxx.xxx.xxx.xxx		
		Mask Addr	xxx.xxx.xxx.xxx		
	ProtocolSet	ArtNet			
		sACN			
	Net Switch	On / Off			
	Fan Settings	Head	Auto		
			High		
			Low		
	Dim Modes	Standard			
		Stage			
		TV			
		Architecur			
		Theatre			
		Stage2			
		Dim Speed	0.1S ~ 10S		
	<i>CONTINUED ON NEXT PAGE</i>				

SYSTEM MENU

PERSONALITY (cont'd from prev page)	LED Refresh Rate	900Hz~1500Hz, 2500Hz, 4000Hz, 5000Hz, 6000Hz, 10KHz, 15KHz, 20KHz, 25KHz		Default = 15KHz
	Dim Curve	Linear		
		Square		
		Inverse Square		
		S-Curve		
	CT Mode	Off / On		
	Reset Motors	Reset All Motors	Yes / No	
		Pan/Tilt Reset	Yes / No	
		Color Reset	Yes / No	
		Gobo Reset	Yes / No	
		Effect/Focus Reset	Yes / No	
		Focus/Zoom Reset	Yes / No	
		Other Reset	Yes / No	
	Display	Intensity	1~ 10	
		Display Invert	Yes / No	
		Screen Saver Delay	Off ~ 10M Default = 5M	
		Key Lock	Off / On / On1	
	Service (Password = 050)	Effect Adjust	Pan Pan Fine Tilt ...	
		USB Port Power	On / Off	
		Update Software	Yes / No	
		Factory Restore	Yes / No	Passcode = 011
MANUAL CONTROL	Pan	000-255		
	Pan Fine	000-255		
	Tilt	000-255		
	Tilt Fine	000-255		
	Cyan	000-255		
	Cyan Fine	000-255		
	Magenta	000-255		
	Magenta Fine	000-255		
<i>CONTINUED ON NEXT PAGE</i>				

SYSTEM MENU

MANUAL CONTROL (cont'd from prev page)	Yellow	000-255	
	Yellow Fine	000-255	
	CTO	000-255	
	CTO Fine	000-255	
	CTO Preset	000-255	
	Color	000-255	
	Gobo1	000-255	
	Gobo1 Rot	000-255	
	Gobo2	000-255	
	Gobo2 Rot	000-255	
	Shutter	000-255	
	Dimmer	000-255	
	Dimmer Fine	000-255	
	Prism 1	000-255	
	Prism 1 Rot	000-255	
	Prism 1 Rot Fine	000-255	
	Prism 2	000-255	
	Prism 2 Rot	000-255	
	Prism 2 Rot Fine	000-255	
	Focus	000-255	
	Focus Fine	000-255	
	Zoom (max to min beam angle)	000-255	
	Zoom Fine (max to min beam angle)	000-255	
	Iris	000-255	
	Iris Fine	000-255	
	Frost	000-255	
	Animation Rot	000-255	
	Blade 1A	000-255	
	Blade 1B	000-255	
	Blade 2A	000-255	
Blade 2B	000-255		
<i>CONTINUED ON NEXT PAGE</i>			

SYSTEM MENU

MANUAL CONTROL (cont'd from prev page)	Blade 3A	000 - 255		
	Blade 3B	000 - 255		
	Blade 4A	000 - 255		
	Blade 4B	000 - 255		
	Frame Rotation	000 - 255		
	Frame Rotation Fine	000 - 255		
	Frame Speed	000 - 255		
	Frame Macros	000 - 255		
	Dim Modes	000 - 255		
	Dim Curves	000 - 255		
	P/T Speed	000 - 255		
	Speed	000 - 255		
	Special Function	000 - 255		
	INTERNAL PROGRAMS	Program 1	Speed	000-255
Fade			000-255	
Program 2		Speed	000-255	
		Fade	000-255	
Program 3		Speed	000-255	
		Fade	000-255	
Program 4		Speed	000-255	
		Fade	000-255	
Program 5		Speed	000-255	
		Fade	000-255	
Program 6		Speed	000-255	
		Fade	000-255	
Program 7		Speed	000-255	
		Fade	000-255	
INFORMATION	Fixture Life Time	Power On Time	xxxxxx Hours	
		P-On Time-R	xxxxxx Hours	
		P-On Time-Reset	Passcode = 050	
	Total LED Time	LED On Time	xxxxxx Hours	
		LED On Time-R	xxxxxx Hours	
		LED Hours Reset	Passcode = 050	

CONTINUED ON NEXT PAGE

SYSTEM MENU

INFORMATION (cont'd from prev page)	Fixture Temps	LEDs	Current	F / C	
			Max Resettable		
			Max Not Resettable		
		Base Temp			
		Reset LED Temp			Passcode = 050
		Reset Base Temp			Passcode = 050
	Fan Info (RPM)	LED Fan 1			
		LED Fan 2			
		LED Fan 3			
		LED Fan 4			
		LED Fan 5			
		Gobo Fan			
		Motor Fan			
		Base Fan1			
		Base Fan2			
	DMX Values	Pan			
		Tilt			
		...			
		Special Function			
	Error Logs	Fixture Errors	List Errors One by One	Passcode = 050	
		Reset Error Log	Yes / No		
	Software Version				

DMX ADDRESSING

All fixtures should be given a DMX starting address when operating with a DMX controller, in order to ensure that the correct fixture responds to the correct control signal. This digital starting address is the channel number from which the fixture starts to “listen” to the digital control signal sent out from the DMX controller. The assignment of this starting DMX address is achieved by setting the correct DMX address on the digital control display on the fixture.

You can set the same starting address for all fixtures or a group of fixtures, or set different addresses for each individual fixture. Setting all fixtures to the same DMX address will cause all fixtures to react in the same way. In this case, please note that changing the settings of one channel will affect all the fixtures simultaneously.

If you set each fixture to a different DMX address, each unit will start to “listen” to the channel number you have set, based on the quantity of DMX channels of each fixture. That means changing the settings of one channel will only affect the selected fixture.

As an example, when operating this fixture model in 36 channel mode, you should set the starting DMX address of the first unit to 1, the second unit to 37 (36 + 1), the third unit to 73 (1 + 36 + 36), and so on. (See the chart below for more details.)

Channel Mode	Unit 1 Address	Unit 2 Address	Unit 3 Address	Unit 4 Address
36 Channels	1	37	73	109
40 Channels	1	41	81	121
51 Channels	1	52	103	154

DMX TRAITS

CHANNEL			VALUES	FUNCTION
36-CH	40-CH	51-CH		
1	1	1	000 - 255	<i>Pan Movement</i> , 630/540
	2	2	000 - 255	<i>Pan Fine</i>
2	3	3	000 - 255	<i>Tilt Movement</i>
	4	4	000 - 255	<i>Tilt Fine</i>
3	5	5	000 - 255	<i>Cyan</i>
		6	000 - 255	<i>Cyan Fine</i>
4	6	7	000 - 255	<i>Magenta</i>
		8	000 - 255	<i>Magenta Fine</i>
5	7	9	000 - 255	<i>Yellow</i>
		10	000 - 255	<i>Yellow Fine</i>
6	8	11	000 - 255	<i>CTO</i>
		12	000 - 255	<i>CTO Fine</i>
7	9	13		<i>White Color Temperature Presets</i>
			000 - 023	Open
			024 - 069	See <i>White Color Temperature Presets</i> section
			070 - 255	6700K
8	10	14		<i>Color Wheel</i>
			000 - 005	Color off (open)
			006 - 011	Red
			012 - 017	Blue
			018 - 023	Green
			024 - 029	Yellow
			030 - 035	CRI
			035 - 041	CTB
			042 - 047	Color off (open)
			048 - 059	Open - Red
			060	Red
			061 - 070	Red - Blue
			071	Blue
			072 - 081	Blue - Green

CONTINUED ON NEXT PAGE

DMX TRAITS

CHANNEL			VALUES	FUNCTION
36-CH	40-CH	51-CH		
8	10	14		<i>Color Wheel</i> (continued)
			082	Green
			083 - 092	Green - Yellow
			093	Yellow
			094 - 104	Yellow - CRI
			105	CRI
			106 - 116	CRI - CTB
			117	CTB
			118 - 126	CTB - Open
			127	Color off (open)
			128 - 190	Clockwise color wheel rotation, fast to slow
			191 - 192	Stop color wheel rotation
			193 - 255	Counter-clockwise color wheel rotation, slow to fast
			9	11
000 - 006	Open			
007 - 013	Gobo 1			
014 - 020	Gobo 2			
021 - 027	Gobo 3			
028 - 034	Gobo 4			
035 - 041	Gobo 5			
042 - 048	Gobo 6			
049 - 055	Gobo 7			
056 - 062	Gobo 1 shake, slow to fast			
063 - 069	Gobo 2 shake, slow to fast			
070 - 076	Gobo 3 shake, slow to fast			
077 - 083	Gobo 4 shake, slow to fast			
084 - 090	Gobo 5 shake, slow to fast			
091 - 097	Gobo 6 shake, slow to fast			
098 - 104	Gobo 7 shake, slow to fast			

CONTINUED ON NEXT PAGE

DMX TRAITS

CHANNEL			VALUES	FUNCTION
36-CH	40-CH	51-CH		
9	11	15		Rotating Gobos , continuous rotation (continued)
			105 - 178	Clockwise gobo wheel rotation, fast to slow
			179 - 181	Stop gobo wheel rotation
			182 - 255	Counter-clockwise gobo wheel rotation, slow to fast
10	12	16		Gobo Rotation
			000 - 127	Gobo Rotation Indexing
			128 - 190	Clockwise Gobo Rotation, fast to slow
			191 - 192	Stop Gobo Rotation
			193 - 255	Counter-clockwise Gobo Rotation, slow to fast
		17	000 - 255	Gobo Rotation Indexing, Fine
11	13	18		Fixed Gobos , continuous rotation
			000 - 006	Open
			007 - 013	Gobo 1
			014 - 020	Gobo 2
			021 - 027	Gobo 3
			028 - 034	Gobo 4
			035 - 041	Gobo 5
			042 - 048	Gobo 6
			049 - 055	Gobo 7
			056 - 062	Gobo 8
			063 - 069	Gobo 1 shake, slow to fast
			070 - 076	Gobo 2 shake, slow to fast
			077 - 083	Gobo 3 shake, slow to fast
			084 - 090	Gobo 4 shake, slow to fast
			091 - 097	Gobo 5 shake, slow to fast
			098 - 104	Gobo 6 shake, slow to fast
			105 - 111	Gobo 7 shake, slow to fast
			112 - 118	Gobo 8 shake, slow to fast
			119 - 185	Clockwise fixed gobo wheel rotation, fast to slow
			186 - 188	Stop fixed gobo wheel rotation
189 - 255	Counter-clockwise fixed gobo wheel rotation, slow to fast			

CONTINUED ON NEXT PAGE

DMX TRAITS

CHANNEL			VALUES	FUNCTION
36-CH	40-CH	51-CH		
12	14	19		Shutter, Strobe
			000 - 031	No function (shutter closed)
			032 - 063	No action, shutter open
			064 - 095	Strobe, slow to fast
			096 - 127	No action, shutter open
			128 - 159	Pulse effect, slow to fast
			160 - 191	No action, shutter open
			192 - 223	Random strobe, slow to fast
			224 - 255	No action, shutter open
13	15	20	000 - 255	Dimmer Intensity , 0% to 100%
	16	21	000 - 255	Dimmer Fine , 0% to 100%
14	17	22		Prism 1
			000 - 031	No effect
			032 - 255	Prism 1 (3 facet)
15	18	23		Prism 1 Rotation
			000 - 127	Prism 1 indexing
			128 - 189	Clockwise rotation, fast to slow
			190 - 193	No rotation
			194 - 255	Counter-clockwise rotation, slow to fast
		24	000 - 255	Prism 1 Index Fine
16	19	25		Prism 2
			000 - 031	No effect
			032 - 255	Prism 2 (4-facet)
17	20	26		Prism 2 Rotation
			000 - 127	Prism 2 indexing
			128 - 189	Clockwise rotation, fast to slow
			190 - 193	No rotation
			194 - 255	Counter-clockwise rotation, slow to fast
		27	000 - 255	Prism 2 Index Fine
18	21	28	000 - 255	Focus , continuous adjustment, far to near
		29	000 - 255	Focus Fine

CONTINUED ON NEXT PAGE

DMX TRAITS

CHANNEL			VALUES	FUNCTION
36-CH	40-CH	51-CH		
19	22	30	000 - 255	Zoom , minimum to maximum beam angle
		31	000 - 255	Zoom Fine
20	23	32		Iris
			000 - 191	Diameter, maximum to minimum
			192 - 223	Pulse opening, fast to slow
			224 - 255	Pulse closing, slow to fast
		33	000 - 255	Iris Fine
21	24	34	000 - 255	Frost , open to full frost
22	25	35		Animation Indexing and Rotation
			000 - 005	Open
			006 - 127	Animation indexing
			128 - 189	Clockwise animation rotation, fast to slow
			190 - 193	No rotation
			194 - 255	Counter-clockwise animation rotation, slow to fast
23	26	36	000 - 255	Blade 1A , 0% to 100%
24	27	37	000 - 255	Blade 1B , 0% to 100%
25	28	38	000 - 255	Blade 2A , 0% to 100%
26	29	39	000 - 255	Blade 2B , 0% to 100%
27	30	40	000 - 255	Blade 3A , 0% to 100%
28	31	41	000 - 255	Blade 3B , 0% to 100%
29	32	42	000 - 255	Blade 4A , 0% to 100%
30	33	43	000 - 255	Blade 4B , 0% to 100%
31	34	44		Frame Rotation
			000 - 126	Minimum (-60 degrees)
			127 - 128	Parallel (0 degrees)
			129 - 255	Maximum (+60 degrees)
		45	000 - 255	Frame Rotation Fine
32	35	46	000 - 255	Frame Speed , maximum to minimum

CONTINUED ON NEXT PAGE

DMX TRAITS

CHANNEL			VALUES	FUNCTION
36-CH	40-CH	51-CH		
33	36	47		Frame Macros (see Frame Macros Chart for details)
			000 - 007	Off
			008 - 015	Macro1
			016 - 023	Macro2
			024 - 031	Macro3
			032 - 039	Macro4
			040 - 047	Macro5
			048 - 055	Macro6
			056 - 063	Macro7
			064 - 071	Macro8
			072 - 079	Macro9
			080 - 087	Macro10
			088 - 095	Macro11
			096 - 103	Macro12
			104 - 111	Macro13
			112 - 119	Macro14
			120 - 127	Macro15
			128 - 135	Macro16
			136 - 143	Macro17
			144 - 151	Macro18
			152 - 159	Macro19
			160 - 167	Macro20
			168 - 175	Macro21
			176 - 183	Macro22
			184 - 191	Macro23
			192 - 199	Macro24
			200 - 207	Macro25
			208 - 215	Macro26
			216 - 223	Macro27
224 - 231	Macro28			
<i>CONTINUED ON NEXT PAGE</i>				

DMX TRAITS

CHANNEL			VALUES	FUNCTION
36-CH	40-CH	51-CH		
33	36	47		Frame Macros (continued, see Frame Macros Chart for details)
			232 - 239	Macro29
			240 - 247	Macro30
			248 - 255	Macro31
34	37	48		Dim Modes
			000 - 020	Default to Unit Setting
			021 - 040	Standard
			041 - 060	Stage
			061 - 080	TV
			081 - 100	Architectural
			101 - 120	Theatre
			121 - 140	Stage 2
				Dim Speed
			141	0.1 s
			142	0.2 s
			143	0.3 s
			144	0.4 s
			145	0.5 s
			146	0.6 s
			147	0.7 s
			148	0.8 s
			149	0.9 s
			150	1.0 s
			151	1.5 s
			152	2.0 s
153	3.0 s			
154	4.0 s			
155	5.0 s			
156	6.0 s			
157	7.0 s			

CONTINUED ON NEXT PAGE

DMX TRAITS

CHANNEL			VALUES	FUNCTION
36-CH	40-CH	51-CH		
34	37	48		<i>Dim Modes</i> (continued)
			158	8.0 s
			159	9.0 s
			160	10 s
			161 - 255	Default to Unit Setting
	38	49		<i>Dim Curves</i>
			000 - 020	Square
			021 - 040	Linear
			041 - 060	Inv. Squa
			061 - 080	S. Curve
			081 - 255	No Function
35	39	50	000 - 255	<i>Pan/Tilt Speed</i> , maximum to minimum speed
36	40	51		<i>Special Functions, Reset, & Internal Programs</i>
			000 - 005	No function
			006 - 010	Normal operation, default refresh rate = 15 kHz
			011	900 Hz
			012	910 Hz
			013	920 Hz
			014	930 Hz
			015	940 Hz
			016	950 Hz
			017	960 Hz
			018	970 Hz
			019	980 Hz
			020	990 Hz
			021	1000 Hz
			022	1010 Hz
			023	1020 Hz
			024	1030 Hz
			025	1040 Hz

CONTINUED ON NEXT PAGE

DMX TRAITS

CHANNEL			VALUES	FUNCTION
36-CH	40-CH	51-CH		
36	40	51		<i>Special Functions, Reset, & Internal Programs (cont'd)</i>
			026	1050 Hz
			027	1060 Hz
			028	1070 Hz
			029	1080 Hz
			030	1090 Hz
			031	1100 Hz
			032	1110 Hz
			033	1120 Hz
			034	1130 Hz
			035	1140 Hz
			036	1150 Hz
			037	1160 Hz
			038	1170 Hz
			039	1180 Hz
			040	1190 Hz
			041	1210 Hz
			042	1220 Hz
			043	1230 Hz
			044	1240 Hz
			045	1250 Hz
			046	1260 Hz
			047	1270 Hz
			048	1280 Hz
			049	1290 Hz
			050	1300 Hz
			051	1310 Hz
			052	1320 Hz
			053	1330 Hz
054	1340 Hz			

CONTINUED ON NEXT PAGE

DMX TRAITS

CHANNEL			VALUES	FUNCTION
36-CH	40-CH	51-CH		
36	40	51		<i>Special Functions, Reset, & Internal Programs (cont'd)</i>
			055	1350 Hz
			056	1360 Hz
			057	1370 Hz
			058	1380 Hz
			059	1390 Hz
			060	1400 Hz
			061	1410 Hz
			062	1420 Hz
			063	1430 Hz
			064	1440 Hz
			065	1450 Hz
			066	1460 Hz
			067	1470 Hz
			068	1480 Hz
			069	1490 Hz
			070	1500 Hz
			071	2500 Hz
			072	4000 Hz
			073	5000 Hz
			074	6000 Hz
			075	10,000 Hz
			076	15,000 Hz
			077	20,000 Hz
			078	25,000 Hz
			079	Disable LED Refresh Rate
			080 - 085	Enable blackout while pan/tilt moving
			086 - 091	Disable blackout while pan/tilt moving
			092 - 097	Enable blackout while color changing
			098 - 103	Disable blackout while color changing

CONTINUED ON NEXT PAGE

DMX TRAITS

CHANNEL			VALUES	FUNCTION
36-CH	40-CH	51-CH		
36	40	51		<i>Special Functions, Reset, & Internal Programs (cont'd)</i>
			104 - 109	Enable blackout while gobo changing
			110 - 115	Disable blackout while gobo changing
			116 - 121	All motors reset
			122 - 127	Pan/tilt reset
			128 - 133	Effect reset
			134 - 139	Color reset
			140 - 145	Gobo reset
			146 - 151	Focus and zoom reset
			152 - 157	Other motors reset
			158 - 163	Fan mode low
			164 - 169	Fan mode high
			170 - 175	Fan mode auto
			176 - 179	Idle
			180 - 189	Internal program 1 (scenes 1-8)
			190 - 199	Internal program 2 (scenes 9-16)
			200 - 209	Internal program 3 (scenes 17-24)
			210 - 219	Internal program 4 (scenes 25-32)
			220 - 229	Internal program 5 (scenes 33-40)
			230 - 239	Internal program 6 (scenes 41-48)
240 - 249	Internal program 7 (scenes 49-56)			
	250 - 252	Enable CT mode		
	253 - 255	Disable CT mode		

WHITE COLOR TEMPERATURE PRESETS

DMX VALUE	COLOR TEMP	DMX VALUE	COLOR TEMP
024	2700	045	4800
025	2800	046	4900
026	2900	047	5000
027	3000	048	5100
028	3100	049	5200
029	3200	050	5300
030	3300	051	5400
031	3400	052	5500
032	3500	053	5600
033	3600	054	5700
034	3700	055	5800
035	3800	056	5900
036	3900	057	6000
037	4000	058	6100
038	4100	059	6200
039	4200	060	6300
040	4300	061	6400
041	4400	062	6500
042	4500	063	6600
043	4600	064	6700
044	4700		

COLOR WHEEL

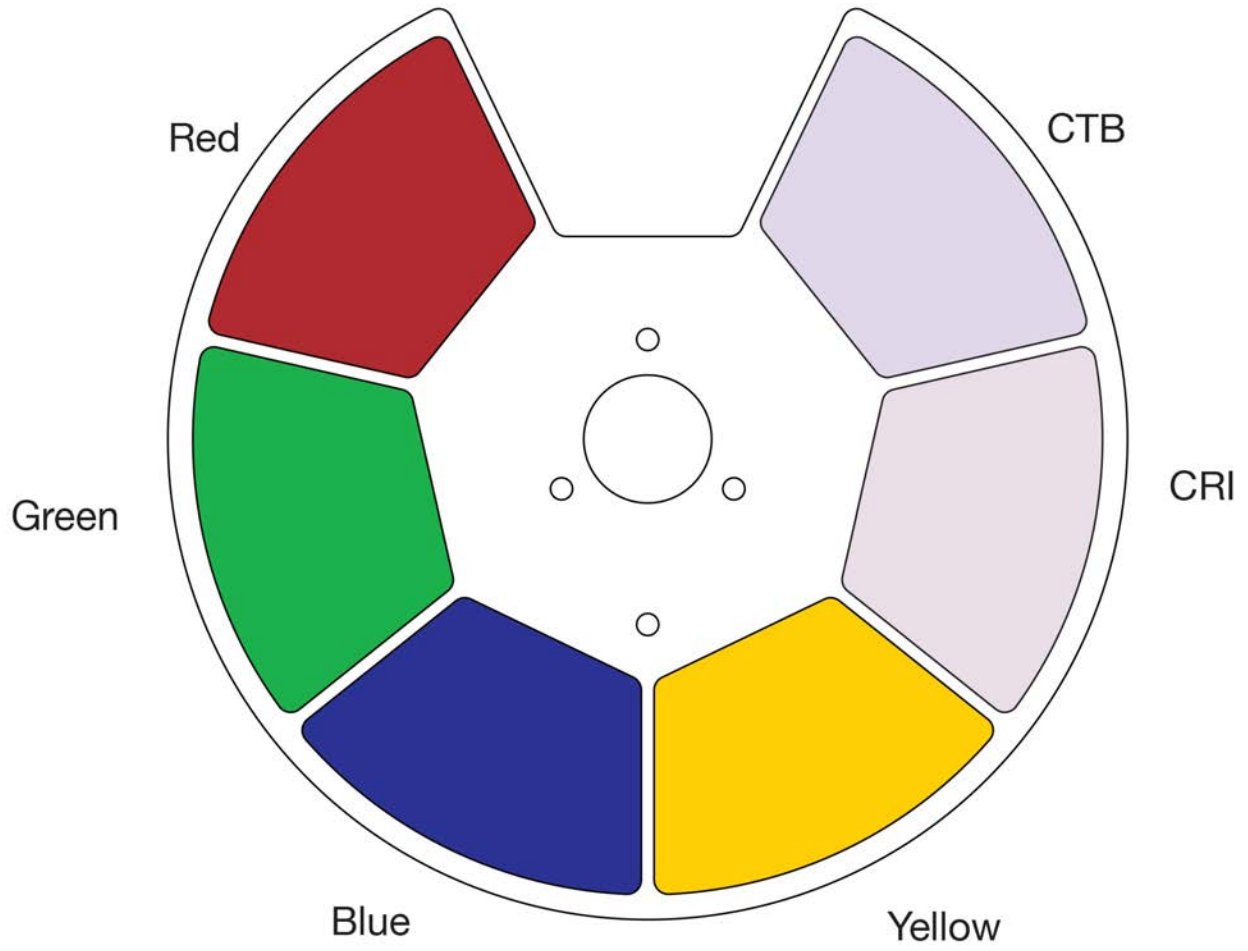

GOBOS

NOTICE REGARDING CUSTOM GOBOS!

Due to the extremely high temperature optical system, special material and design requirements are required for the gobos! Due to varying gobo manufacturing processes and tolerances, when working with a custom gobo vendor, it is highly recommended to provide a gobo sample from the fixture for accurate sizing and materials. Extended testing of custom gobo designs is highly recommended prior to use.

GOBO DESIGNS

Rotating Gobos

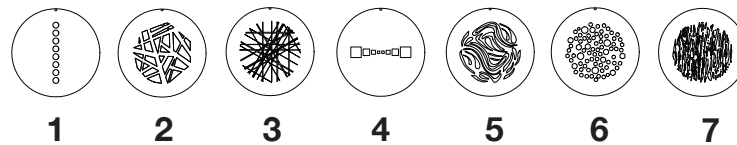

Fixed Gobos

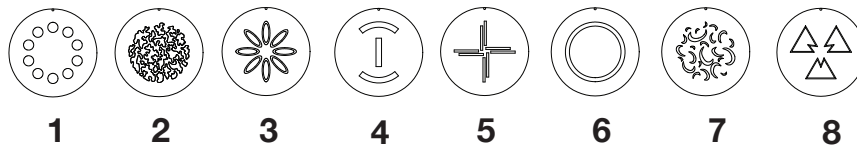

GOBO DIMENSIONS

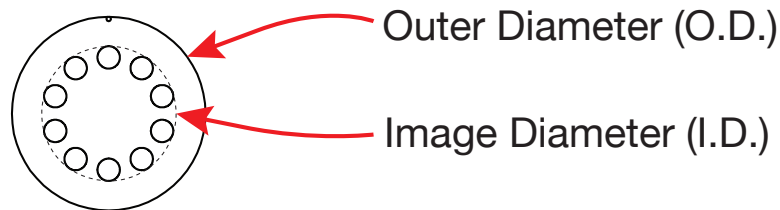

	ROTATING GOBO	FIXED GOBO
<i>OUTER DIAMETER</i>	0.9in (23.0mm)	0.9in (23.0mm)
<i>IMAGE DIAMETER</i>	0.6in (16.0mm)	0.5in (13.0mm)
<i>THICKNESS</i>	0.043in ± 0.004in (1.1mm ± 0.1mm)	0.043in ± 0.004in (1.1mm ± 0.1mm)
<i>MATERIAL</i>	metal	metal

DIMMER MODES AND CURVES

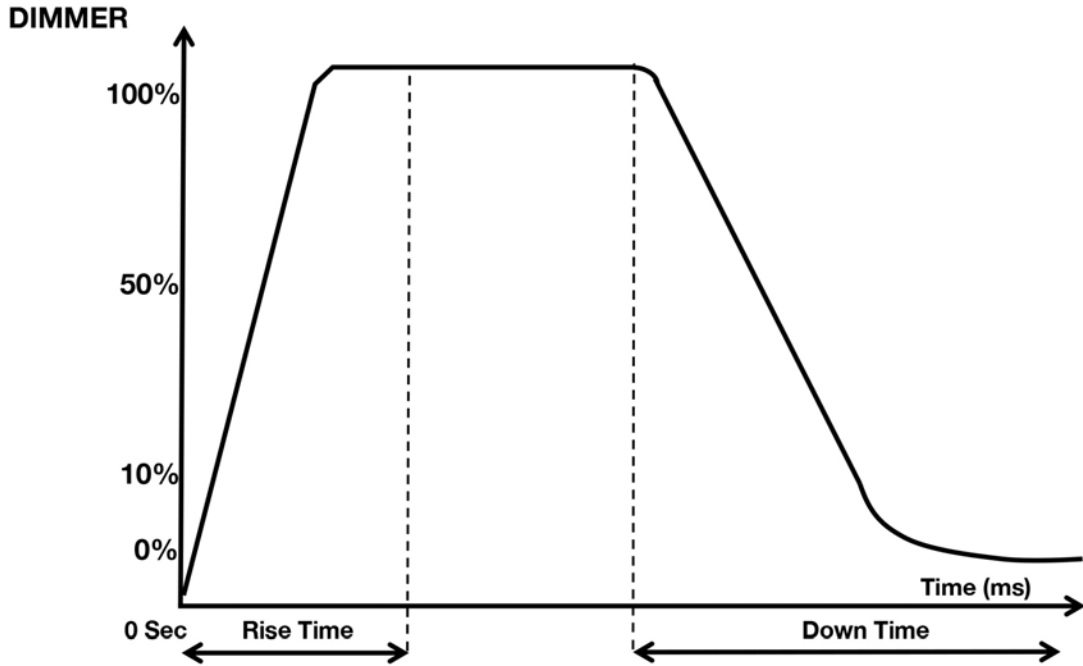

Dimming Curve Ramp Effect	0 sec Fade Time		1 sec Fade Time	
	Rise Time (ms)	Down Time (ms)	Rise Time (ms)	Down Time (ms)
Standard (default)	0	0	0	0
Stage	780	1100	1540	1660
TV	1180	1520	1860	1940
Architectural	1380	1730	2040	2120
Theatre	1580	1940	2230	2280
Stage 2	0	1100	0	1660

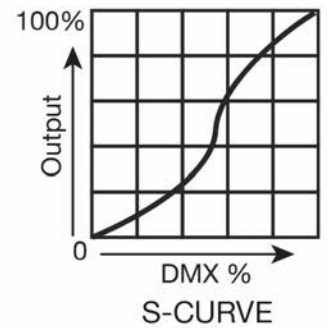
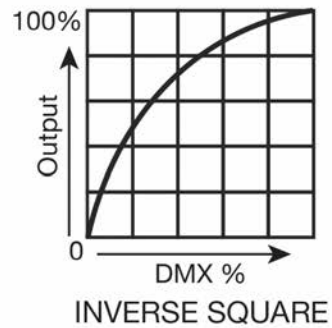
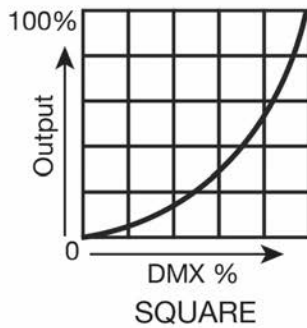
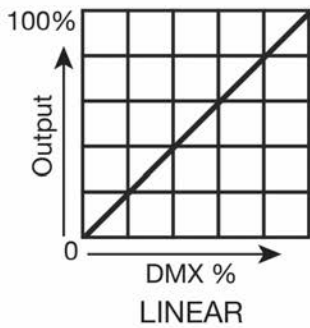

FRAME MACROS TABLE

FRAME MACRO NO.	BLADE 1A	BLADE 1B	BLADE 2A	BLADE 2B	BLADE 3A	BLADE 3B	BLADE 4A	BLADE 4B
1	150	0	150	0	150	0	150	0
2	138	116	126	0	162	206	88	146
3	146	0	208	70	166	0	162	168
4	220	0	122	0	166	0	114	64
5	0	104	0	124	0	162	64	132
6	88	74	132	240	84	144	114	60
7	144	74	0	255	10	108	48	116
8	138	116	198	0	162	106	112	78
9	96	100	0	130	162	0	0	172
10	138	216	134	0	0	206	88	146
11	88	94	0	244	46	112	114	44
12	138	216	140	0	0	206	0	0
13	124	62	216	0	108	206	126	2
14	152	118	128	106	136	102	68	114
15	124	54	0	154	16	118	126	206
16	0	214	2	146	0	124	0	128
17	144	74	0	152	10	240	138	74
18	102	120	56	202	30	102	152	40
19	174	104	100	124	194	152	64	132
20	88	74	132	240	84	102	114	172
21	86	112	168	0	228	26	122	64
22	146	0	208	70	166	0	162	0
23	138	116	126	0	162	206	112	78
24	150	154	150	0	150	0	150	86
25	122	0	0	196	150	0	150	86
26	182	0	98	124	162	64	0	168
27	210	0	120	0	166	0	162	0
28	88	92	150	0	228	144	114	0
29	122	0	0	130	162	0	220	86
30	124	54	216	154	16	118	126	2
31	138	116	198	142	0	160	138	80

CLEANING AND MAINTENANCE

WARNING! DISCONNECT UNIT FROM POWER BEFORE PERFORMING ANY CLEANING OR MAINTENANCE PROCEDURES!

ALWAYS ALLOW THE FIXTURE TO COOL FOR AT LEAST 15 MINUTES BEFORE PERFORMING ANY CLEANING OR MAINTENANCE!

CLEANING

Frequent cleaning is recommended to ensure proper function, optimized light output, and an extended life. The frequency of cleaning depends on the environment in which the fixture operates: damp, smoky, or particularly dirty environments can cause greater accumulation of dirt on the fixture's optics. Clean periodically with a soft cloth to avoid dirt/debris accumulation.

NEVER use alcohol, solvents, or ammonia-based cleaners.

MAINTENANCE

Regular inspections are recommended to insure proper function and extended life. There are no user serviceable parts inside this fixture. Please refer all other service issues to an authorized ADJ service technician. Should you need any spare parts, please order genuine parts from an authorized ADJ dealer.

Please refer to the following points during routine inspections:

- A detailed electrical check by an approved electrical engineer every three months, to make sure the circuit contacts are in good condition and prevent overheating.
- Be sure all screws and fasteners are securely tightened at all times. Loose screws may fall out during normal operation, resulting in damage or injury as larger parts could fall.
- Check for any deformations on the housing, color lenses, rigging hardware and rigging points (ceiling, suspension, trussing). Deformations in the housing could allow for dust to enter into the fixture. Damaged rigging points or unsecured rigging could cause the fixture to fall and seriously injure a person(s).
- Electric power supply cables must not show any damage, material fatigue or sediments.

FUSE REPLACEMENT

Disconnect the unit from the power source, then use a flat head screw driver to unscrew the fuse holder located next to the Power In port. Remove the bad fuse and replace with a new one, then screw the fuse holder back in. **Replace only with a new fuse of the same type and rating.**

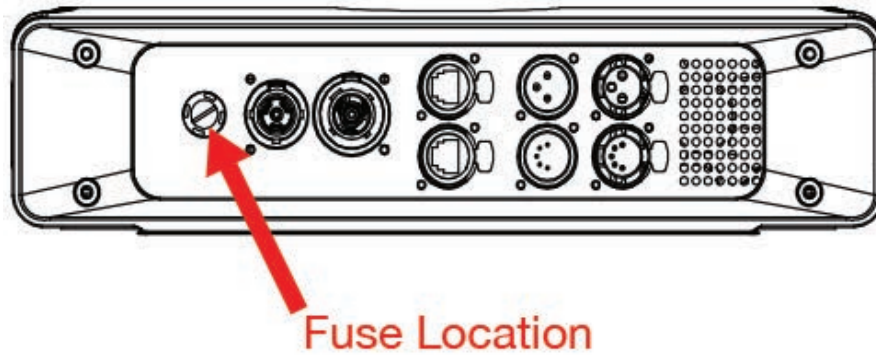

SOFTWARE UPDATES

ONLY QUALIFIED TECHNICIANS SHOULD PERFORM THIS FUNCTION! NOTE ALL MENU SETTINGS BEFORE UPDATING SOFTWARE!

FIXTURE SOFTWARE CANNOT BE DOWNGRADED!

DOWNLOAD FIXTURE SOFTWARE TO PC ONLY! (NO MAC SUPPORT)

PLEASE CONTACT ADJ CUSTOMER SERVICE FOR FURTHER INFORMATION.

1. Contact ADJ customer service to obtain the updated software. Download software to a USB flash drive. In order to minimize the risk of downloading the incorrect software to your device, make sure that the desired update files are the only files on the USB flash drive.
2. Disconnect any DMX connections from your device. Insert the USB flash drive into the service port on your device.
3. Use the display screen control panel to navigate to Personality > Service > USB Port Power. See the **System Menu** section of this manual for detailed instructions. Enter the passcode when prompted, and switch the USB Port Power setting to ON.
4. Highlight the desired file and press ENTER to select it and begin the download.
5. The unit will now update, run an automatic software check, and reset. This may take some time.
6. Repeat this process for each software update file.
7. Verify by navigating to Information > Software Version and confirming that the correct software version number is shown there (see the **System Menu** section of this manual for detailed instructions).

DIMENSIONAL DRAWINGS

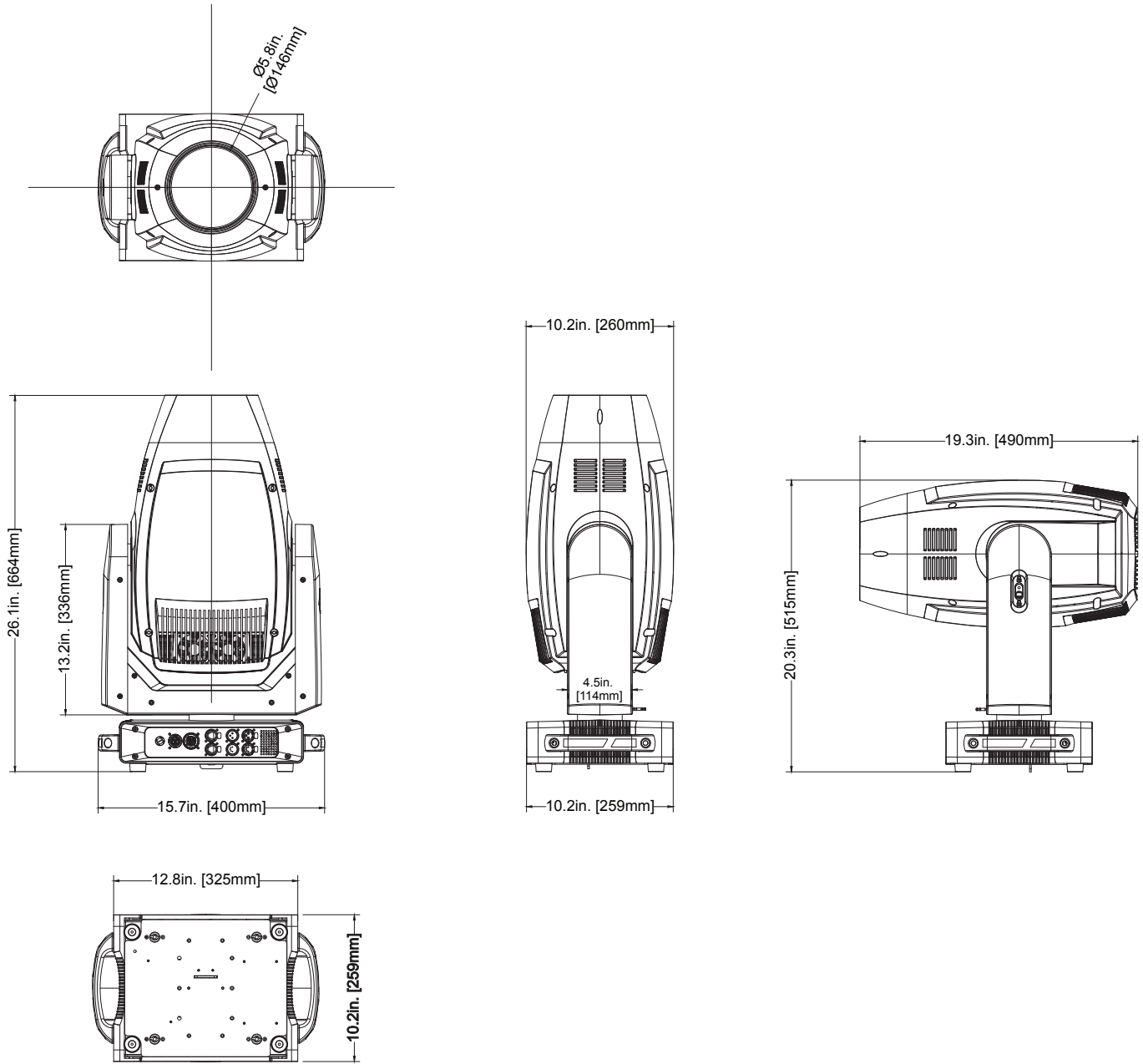

Drawings may not be to scale.

SPECIFICATIONS

SOURCE

- 400W LED Engine
- 20,000 Hour Average LED Life

PHOTOMETRIC DATA

- 20,000 Total Lumens
- 6,700K, >70CRI (without CRI Filter)
- 6,200K >87CRI (with CRI Filter)
- 44,330 LUX 4,118 FC @16.4' (5m) (7.32° Beam)
- 1,767 LUX 164 FC @16.4' (5m) (45° Beam)

EFFECTS

- 4 Rotating Framing Shutters plus shape rotation
- 3-Facet Circular & 6-Facet Linear Rotating Prisms
- Replaceable Medium Frost Filter
- Animation Wheel
- Motorized Zoom (7~45-degrees)
- Motorized Focus
- Motorized Iris
- Electronic Dimming & Strobe (1-20Hz)

COLOR

- Full CMY color mixing
- Variable CTO (2700K to 6700K)
- Colors Wheel with 6 dichroic colors

GOBOS

- (2) Gobo Wheels
- #1 - (7) Interchangeable Rotating-Indexing Gobos
- #2 - (8) Static-Stamped Gobos

CONTROL / CONNECTIONS

- (3) DMX Channel Modes (36 / 40 / 51)
- RDM (Remote Device Management)
- 6 Button Touch Control Panel
- Full Color 180° Reversible LCD Menu Display
- 8 / 16 Bit Resolution Adjustable Movement
- 3 & 5 pin XLR DMX In/Out
- RJ45 Ethernet In/Out (Art-NET)
- Locking In/Out power connections
- With Wired Digital Communication Network

PAN / TILT

- Pan: 540-degrees
- Tilt: 270-degrees
- Pan & Tilt Locks

SIZE / WEIGHT

- Length: 15.7" (400mm)
- Width: 10.2" (259mm)
- Vertical Height: 26.1" (664mm)
- Weight: 61.2 lbs. (27.75kg)

ELECTRICAL / THERMAL

- **AC 100-240V - 50/60Hz**
- Max Power Consumption: 560W
- Max ambient temperature: -13°F to 113°F (-25°C to 45°C)
- Max housing temperature: 136°F (58°C)

TECHNICAL DATA

- DB Rating @ 3ft.: 49dB
- BTU: 0.53
- BTU/H: 1,909.60

APPROVALS / RATINGS

- CE | ETL
- IP20

Specifications and documentation subject to change without prior written notice.

ERROR CODES

ERROR CODES	Pan Tilt LEDTemp LEDFan1 LEDFan2 LEDFan3 LEDFan4 MotorFan1 Cyan Magenta Yellow CTO LEDFan5 Color Gobo1 Gobo1Rot Gobo2 Animation GoboFan Blade Zoom Focus Frost Prism1 Prism1Rot Prism2 Prism2Rot BaseTemp BaseFan1 BaseFan2
----------------	--

